

D8



Quick Start

- 8K@60 input
- Built-in 4" LCD touch screen control
- 8K EDID management
- Genlock synchronization unequal splicing, multiple splicing layouts available
- Layer cropping and scaling
- Genlock input and loop through
- XPOSE 2.0 control
- Support standard output resolution and customize output resolution
- Hot swap
- open API

Content

- Overview 3
- Packing Configuration 4
- Hardware Orientation 5
 - Front Panel 5
 - Rear Panel 6
- Install Your Product 7
 - Plug in Power 7
 - Connect Signal Source and Control Computer 7
 - Turn on Your Product 8
- Use Your Product 9
 - Main Interface 9
 - Device 9
 - Settings 9
 - Load Presets 12
 - Language 13
 - Version 13
 - XPOSE 2.0 14
- Contact Information 15

Overview

The D series has always been regarded as the leader in presentation-level image quality processing at different display stages in the industry. D8 continues to lead the display technology to become an 8K@60-level video processor in the industry. Create a visual experience.

The **D8** is standard with one HDMI 2.1 input interface and **D8 PLUS** is standard with one HDMI 2.1 input interface and one DP 1.4 input interface, which can meet the requirements of 8K input signal transmission. The D8 is equipped with a 4-inch LCD touch screen, which optimizes the overall front panel aesthetic design.

System Connection

RGBlink offers solutions to demanding technical problem. Any application questions, or required further information, please contact with our customer Support Engineers.

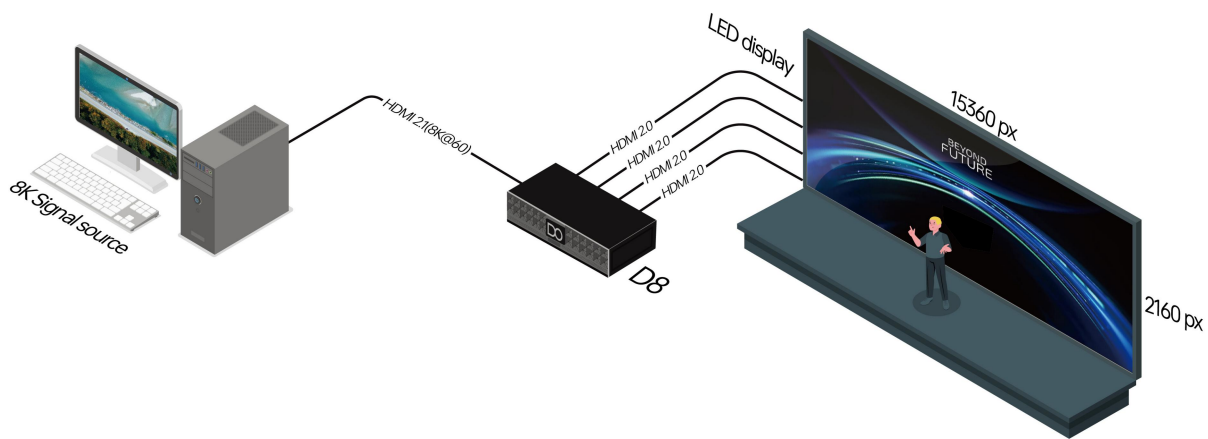

SYSTEM CONNECTION DIAGRAM

Packing Configuration

1 x AC Power Cord



1 x Network Cable



1 x DB9 to USB Cable



1 x DB9 to RJ11 Cable



1 x 8K HDMI Cable



1 x 8K DP Cable



Note:

1. AC Power Cable supplied as standard according to destination market.
1. We offer 8K HDMI Cable for D8 model; 8K HDMI Cable and 8K DP Cable for D8 PLUS model.

Hardware Orientation

Front Panel

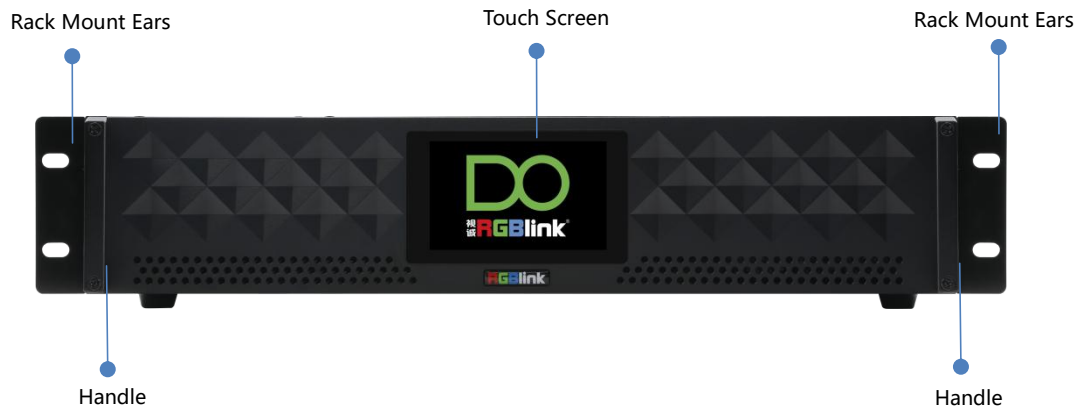

Name	Description
Touch Screen	4-inch LCD touch screen allows you to directly control D8, which optimizes the user experience.
Rack Mount Ears	Use with the load-bearing screws to fix device on the rack.
Handles	For carrying device.

Rear Panel

D8

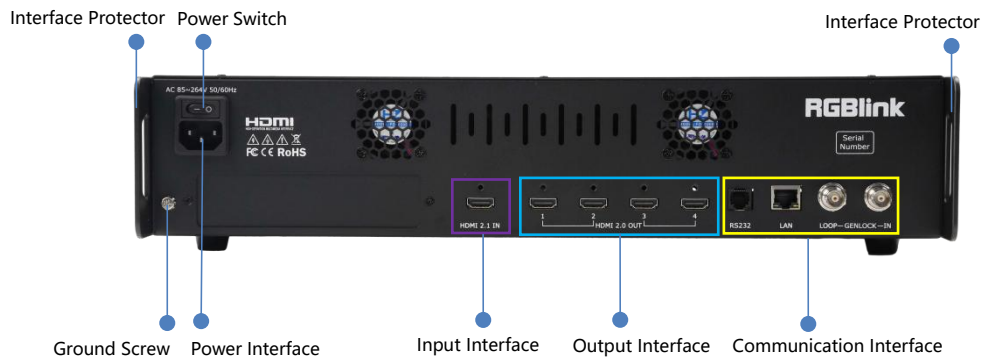

D8 PLUS

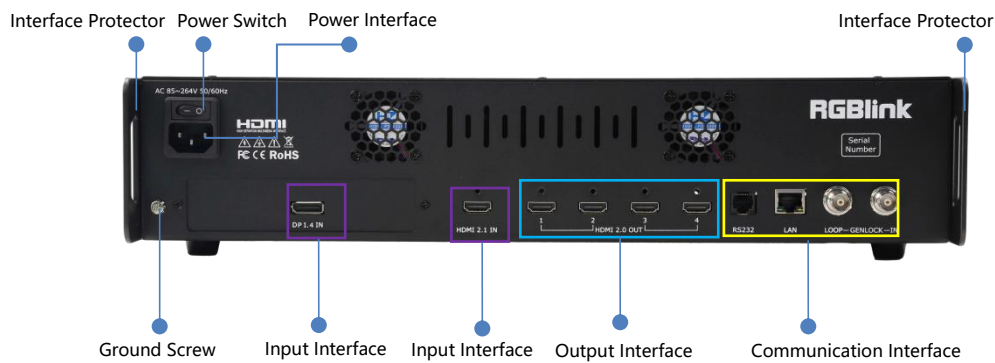

Name	Description
Input Interface	<ul style="list-style-type: none"> D8 is standard with one HDMI 2.1 input interface D8 PLUS is standard with one HDMI 2.1 input interface and one DP 1.4 input interface
Output Interface	Standard with Quad HDMI 2.0 Output Module
Communication Interface	Standard with 1xRS 232 Serial Port, 1xLAN Network Port, 1xIN-GENLOCK-LOOP Port
Power Interface	Connect standard power cable to device and plug into wall socket
Power Switch	Power on or off the device
Interface Protector	Used to pull out device, fix cables and protect interfaces from collision
Ground Screw	Increase the safety and reliability, and avoid accidents such as fire and explosion caused by static electricity

Install Your Product

Note: D8 and D8 PLUS are same in installation. This chapter takes D8 as example.

Plug in Power



Connect power and D8 with standard Power Cord. Plug one end of the power cable to the D8's power interface. The other end is connected to the power socket.

Connect Signal Source and Control Computer

Connect D8 with Camera ,PC, laptop as input signal, connect D8 with monitors, as shown in the figure below.

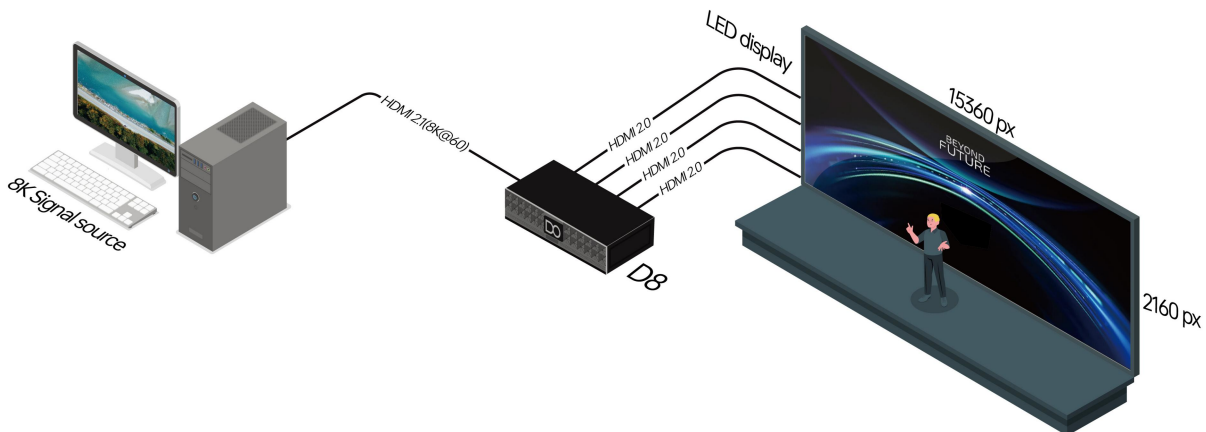

Connect RS232 port of device and computer with serial cable to perform direct connection via **Serial Connection**. Then you can do control via XPOSE 2.0 software.



Turn on Your Product



Push the power switch on the rear panel and the system begins to work.

Use Your Product

Main Interface

Turn on D8, and the Main Interface includes Menu and SN serial number.

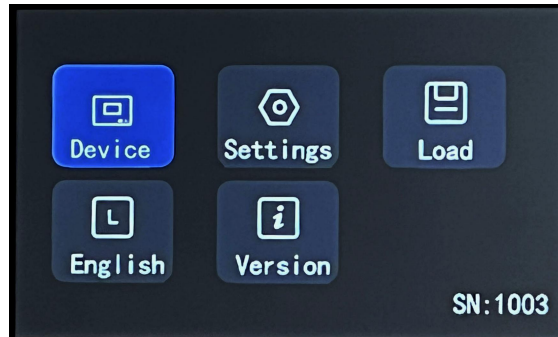

Note: Click the previous option to exit current interface step-by-step until back to Main Interface.

Device

Click <Device> to check Input and Output Status and Resolution.

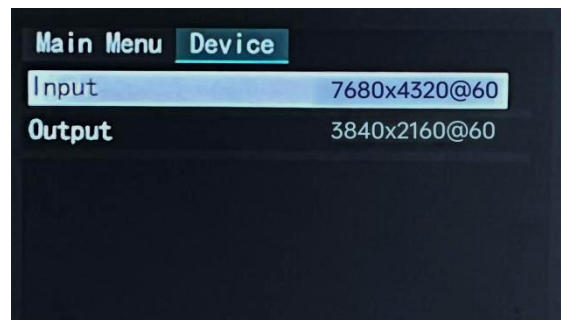

Settings

Click <Main Menu> to return to the Main Interface. Click <Settings> to set Output Resolution, choose Split Layout, perform EDID Management, do Layer Cropping and Scaling.

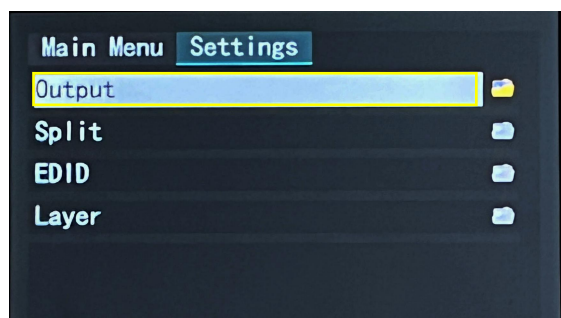

Output

Click **<Output>** to choose Standard Resolution or Custom Resolution.

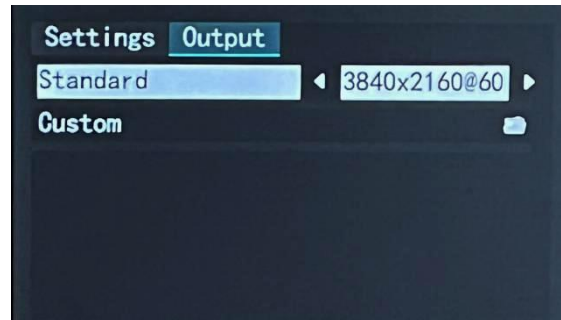

Standard Resolution

Select standard resolution and then click "Enter" to save and the touch screen returns back to previous interface for you to double check.

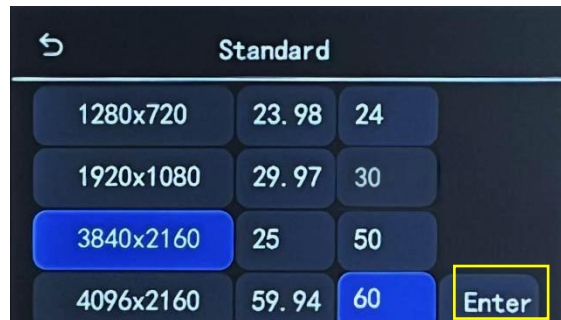

Customize Resolution

Type in Width, Height and Frequency one by one and click "Enter">"Save Settings". Then check the set resolution in <Device> interface.

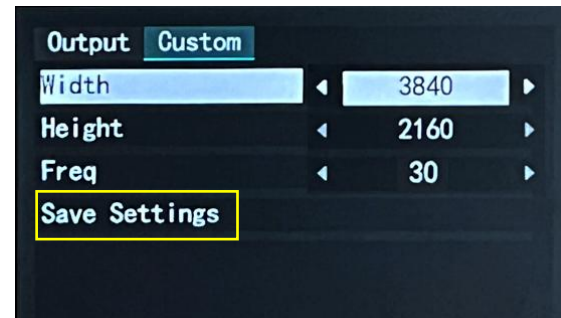

Split

Back to <Settings>, click **<Split>** to choose splicing layout and configure parameters. 3 split modes available, including Cross (by default), H 1/4 and V 1/4.

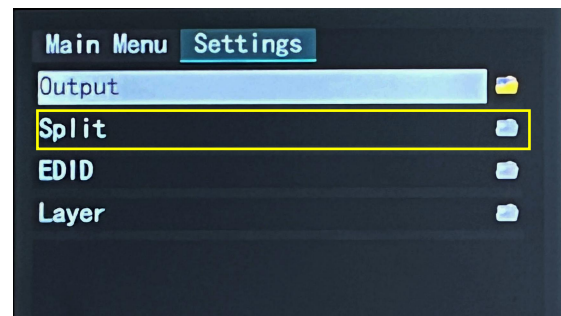

Select layout, then set parameters, such as H Total, V Total of screen according to actual need. Use the numeric keyboard to enter parameters, then click "Save Settings" > "Confirm" to save above settings.

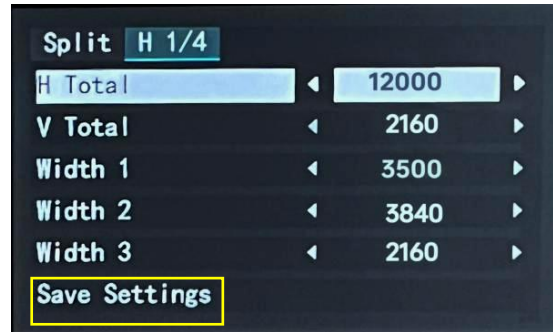
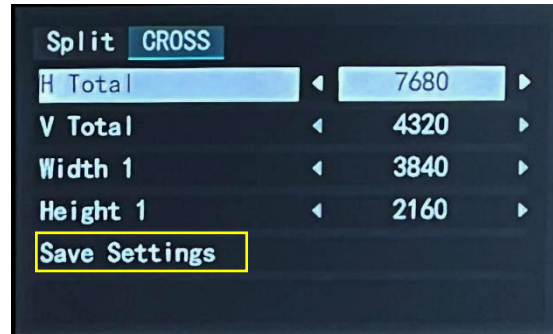

EDID

Back to <Settings>, click <EDID> for EDID management.

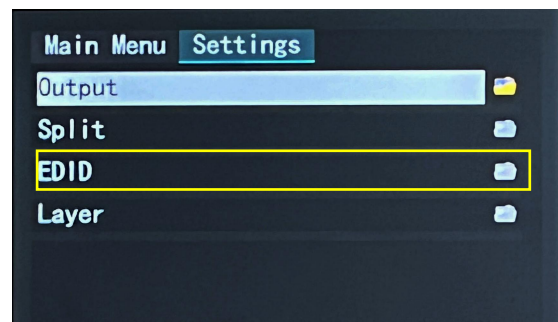

Customize EDID

Use the numeric keyboard to enter the Width, Height and Frequency one by one and then click "Apply" > "Confirm".

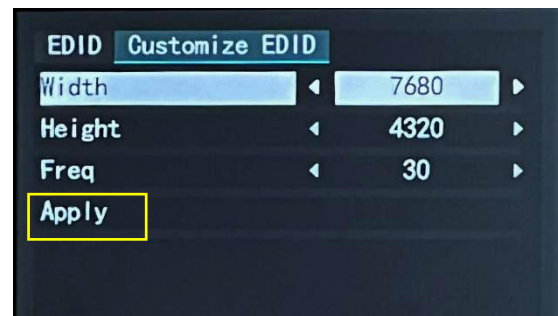

Note: The resolution on the signal source (such as a computer) needs to be same as the D8. Refer to <User Manual> for details.

Reset EDID

Click "Reset EDID" > "Confirm" to clear previous settings.



Layer

Back to <Settings>, then click <Layer> to do Layer Scaling and Cropping.

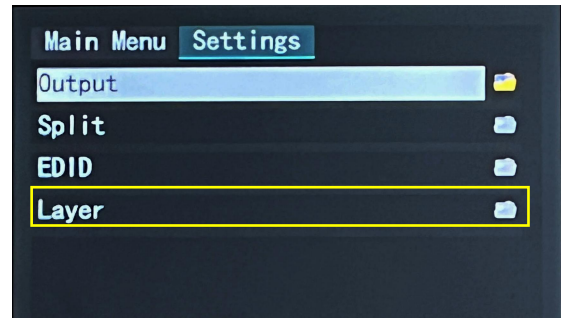

Type horizontal position, Vertical position, Width and Height as needed. Then click "Save Settings" > "Confirm" to save above parameters.

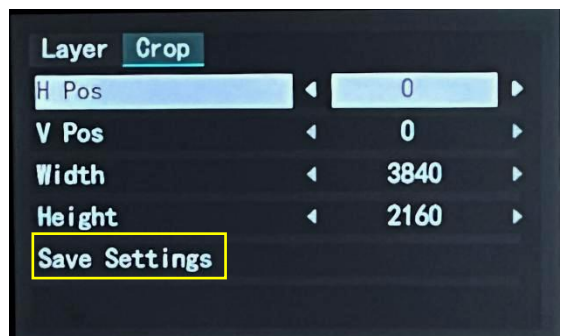
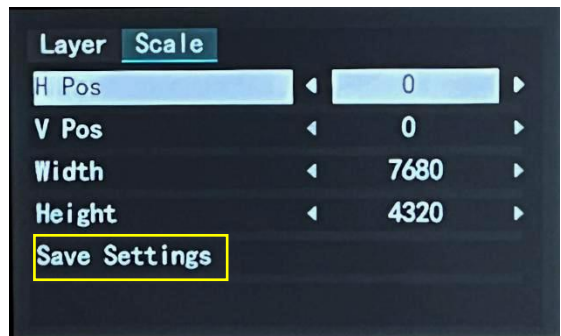

Load Presets

Back to Main Interface, then click <Load> to load presets.

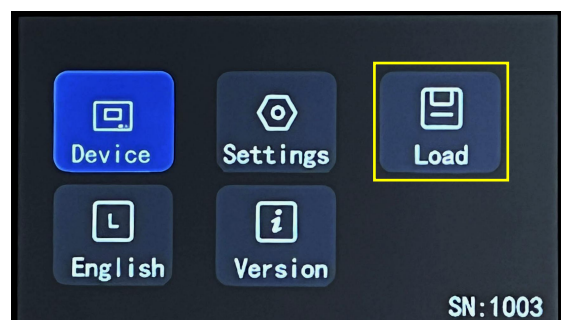

D8 provides 16 positions for saving banks. Yellow background: current bank; Green background: with parameter saved; Grey background: empty bank.

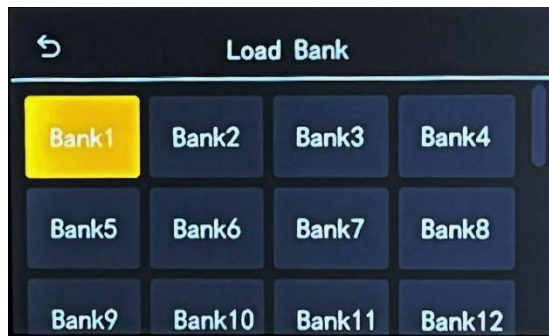

Note: Please do Scene Setting in XPOSE 2.0 firstly and then you can load bank.

Language

Back to Main Interface, then click **<English>** to set system language.

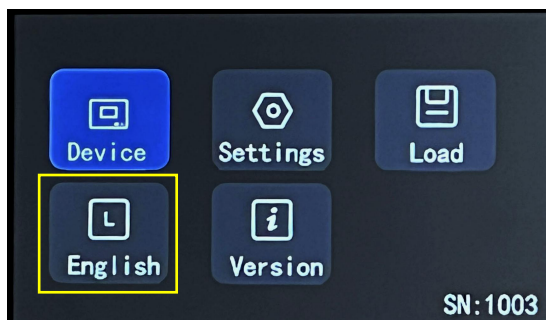

English and Simplified Chinese available.

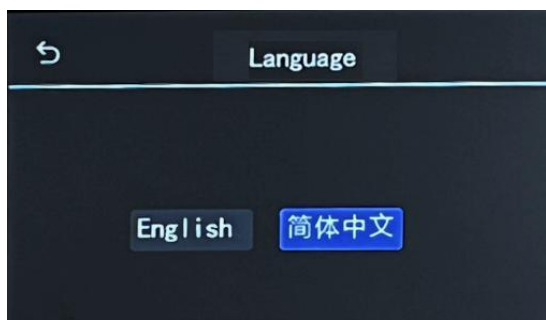

Version

Back to Main Interface, then click **<Version>**.

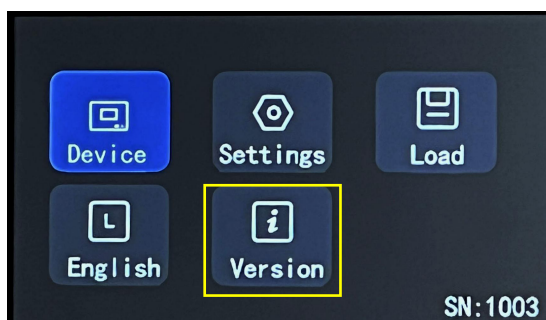

You can check Panel Version and Main Board Version.



XPOSE 2.0

Physically Connect Device to Computer

Use RJ11-DB9 serial cable to connect RS232 port of device and computer.

XPOSE 2.0 Operation

Download XPOSE 2.0 software from RGBlink website.

https://www.rgblink.com/xpose_software.aspx

Please refer to user manual of D8 for how to install and operate XPOSE 2.0.

<https://rgblink-web.azurewebsites.net/productsinfo.aspx?id=232>

Contact Information

Warranty:

All video products are designed and tested to the highest quality standard and backed by full 1 years parts and labor warranty. Warranties are effective upon delivery date to customer and are non-transferable. RGBlink warranties are only valid to the original purchase/owner. Warranty related repairs include parts and labor, but do not include faults resulting from user negligence, special modification, lighting strikes, abuse(drop/crush), and/or other unusual damages.

The customer shall pay shipping charges when unit is returned for repair.

Headquarter: Room 601A, No. 37-3 Banshang community, Building 3, Xinke Plaza, Torch Hi-Tech Industrial Development Zone, Xiamen, China

- **Tel:** +86-592-5771197
- **Fax:** +86-592-5788216
- **Customer Hotline:** 4008-592-315
- **Web:** <http://www.rgblink.com>
- **E-mail:** support@rgblink.com