

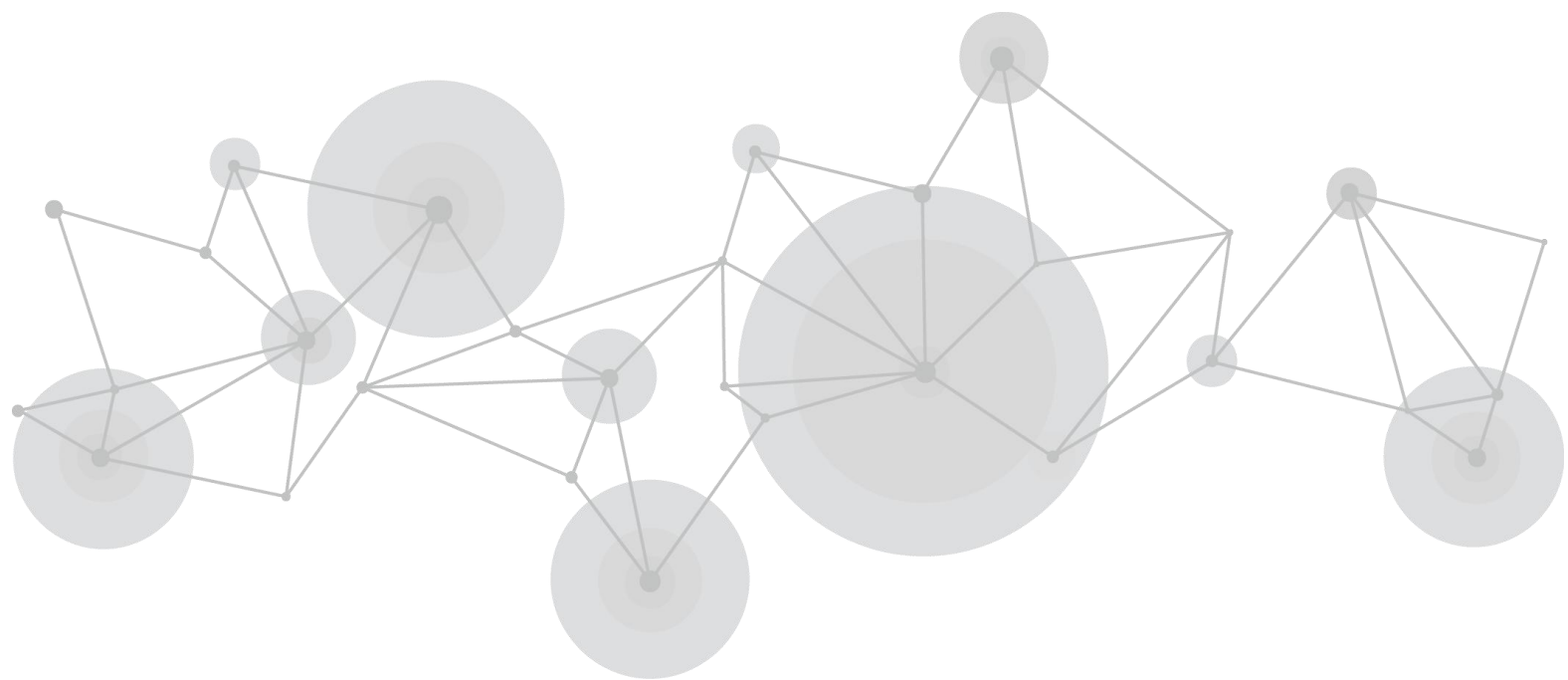

mini-mx



User Manual



Content

Declarations	5
FCC/Warranty	5
Operators Safety Summary	6
Installation Safety Summary	7
Chapter 1 Your Product	9
1.1 In the Box	9
1.2 Product Overview	10
1.2.1 Key Features	11
1.2.2 Front Panel	12
1.2.3 Interface Panel	14
1.2.4 Dimension	16
Chapter 2 Install Your Product	17
2.1 Connecting HDMI Input.....	17
2.2 Connecting HDMI Output.....	17
2.3 Connecting Microphone and External Monitoring Devices	18
2.4 Connecting USB for Streaming and Recording	19
2.5 Connecting Router	20
2.6 Plugging in Power	20

2.7 Turning on Your mini-mx.....	21
Chapter 3 Use Your Product.....	22
3.1 Main Interface	22
3.2 MENU	24
3.3 Editing Interface	24
3.4 PIP (Picture-in-Picture)	26
3.5 Adding Layers	27
3.5.1 Layer Storage Path	28
3.5.2 Adding Background	30
3.5.3 Adding Layer A	31
3.5.4 Adding Layer B	33
3.5.5 Adding LOGO	34
3.5.6 Adding Overlay	35
3.5.7 Adding Scoreboard	37
3.6 Chroma Key	38
3.7 Controlling PTZ Camera	39
3.8 Saving and Loading Scenes	44
3.9 Video Output	46
3.9.1 Multi-view	46
3.9.2 Program	47
3.9.3 Resolution	47
3.9.4 USB2 Mode	48

3.9.5 TAO Cloud Device Access	48
3.10 Streaming	50
3.10.1 Direct Connection	51
3.10.2 Smartphone Tethering	52
3.10.3 YouTube Live	55
3.10.4 Controlling PTZ Camera During Live	57
3.11 Recording	58
3.12 Switch Effect Setting	60
3.13 Audio	64
3.14 Setting	68
3.14.1 About	68
3.14.2 Date and Time	69
3.14.3 Language	70
3.14.4 Bluetooth	70
3.14.5 Views Auto Loop	71
3.14.6 VFA	71
3.14.7 Switch Mode	73
3.14.8 Reset	74
3.14.9 Auto Return	74
3.14.10 Fan	74
3.14.11 Display	75
3.14.12 T-Bar Correction	75

3.14.13 Color Management	76
Chapter 4 Ordering Codes.....	77
4.1 Product Code	77
Chapter 5 Appendix.....	78
5.1 Specification	78
5.2 FAQ	79
5.3 Upgrade	84
5.3.1 U Disk Upgrade	84
5.3.2 Online Upgrade	86
5.4 Terms & Definitions	89
5.5 Revision History	95
Chapter 6 Support.....	97

Thank you for choosing our product!

This User Manual is designed to show you how to use this product quickly and make use of all the features. Please read all directions and instructions carefully before using this product.

Declarations

FCC/Warranty

Federal Communications Commission (FCC) Statement

This equipment has been tested and found to comply with the limits for a class A digital device, pursuant to Part 15 of the FCC rules. These limits are designed to provide reasonable protection against harmful interference when the equipment is operated in a commercial environment. This equipment generates, uses, and can radiate radio frequency energy and, if not installed and used in accordance with the instruction manual, may cause harmful interference to radio communications. Operation of this equipment in a residential area may cause harmful interference, in which case the user will be responsible for correcting any interference.

Guarantee and Compensation

RGBlink provides a guarantee relating to perfect manufacturing as part of the legally stipulated terms of guarantee. On receipt, the purchaser must immediately inspect all delivered goods for damage incurred during transport, as well as for material and manufacturing faults. RGBlink must be informed immediately in writing of any complains.

The period of guarantee begins on the date of transfer of risks, in the case of special systems and software on the date of commissioning, at latest 30 days after the transfer of risks. In the event of justified notice of compliant, RGBlink can repair the fault or provide a replacement at its own

discretion within an appropriate period. If this measure proves to be impossible or unsuccessful, the purchaser can demand a reduction in the purchase price or cancellation of the contract. All other claims, in particular those relating to compensation for direct or indirect damage, and also damage attributed to the operation of software as well as to other service provided by RGBlink, being a component of the system or independent service, will be deemed invalid provided the damage is not proven to be attributed to the absence of properties guaranteed in writing or due to the intent or gross negligence or part of RGBlink.

If the purchaser or a third party carries out modifications or repairs on goods delivered by RGBlink, or if the goods are handled incorrectly, in particular if the systems are commissioned operated incorrectly or if, after the transfer of risks, the goods are subject to influences not agreed upon in the contract, all guarantee claims of the purchaser will be rendered invalid. Not included in the guarantee coverage are system failures which are attributed to programs or special electronic circuitry provided by the purchaser, e.g. interfaces. Normal wear as well as normal maintenance are not subject to the guarantee provided by RGBlink either.

The environmental conditions as well as the servicing and maintenance regulations specified in this manual must be complied with by the customer.

Operators Safety Summary

The general safety information in this summary is for operating personnel.

Do Not Remove Covers or Panels

There are no user-serviceable parts within the unit. Removal of the top cover will expose dangerous voltages. To avoid personal injury, do not remove the top cover. Do not operate the unit without the cover installed.

Power Source

This product is intended to operate from a power source that will not apply more than 230 volts rms between the supply conductors or between both supply conductor and ground. A protective ground connection by way of grounding conductor in the power cord is essential for safe operation.

Grounding the Product

This product is grounded through the grounding conductor of the power cord. To avoid electrical shock, plug the power cord into a properly wired receptacle before connecting to the product input or output terminals. A protective-ground connection by way of the grounding conductor in the power cord is essential for safe operation.

Use the Proper Power Cord

Use only the power cord and connector specified for your product. Use only a power cord that is in good condition. Refer cord and connector changes to qualified service personnel.

Use the Proper Fuse

To avoid fire hazard, use only the fuse having identical type, voltage rating, and current rating characteristics. Refer fuse replacement to qualified service personnel.

Do Not Operate in Explosive Atmospheres

To avoid explosion, do not operate this product in an explosive atmosphere.

Installation Safety Summary

Safety Precautions

For all product installation procedures, please observe the following important safety and handling rules to avoid damage to yourself and the equipment.

To protect users from electric shock, ensure that the chassis connects to earth via the ground wire provided in the AC power Cord.

The AC Socket-outlet should be installed near the equipment and be easily accessible.

Unpacking and Inspection

Before opening product shipping box, inspect it for damage. If you find any damage, notify the shipping carrier immediately for all claims adjustments. As you open the box, compare its contents against the packing slip. If you find any shortages, contact your sales representative.

Once you have removed all the components from their packaging and checked that all the listed components are present, visually inspect the system to ensure there was no damage during shipping. If there is damage, notify the shipping carrier immediately for all claims adjustments.

Site Preparation

The environment in which you install your product should be clean, properly lit, free from static, and have adequate power, ventilation, and space for all components.

Chapter 1 Your Product

1.1 In the Box

mini-mx is equipped with **Power Adapter*1, USB-C to USB-C Cable *2, USB-C to USB-A Cable *1, Stand*2, Quick Start*1.**

★Power Adapter



USB-C to USB-C Cable



USB-C to USB-A Cable



★Stands



Quick Start



Warning:

1. The standard power supply can **ONLY** be used with the mini-mx, and is cannot be used for powering other devices simultaneously. RGBlink disclaim all responsibility for instability or damage caused by improper use.
2. Portable stands with strong tapes can be attached to the back of mini-edge for support and heat dissipation. Refer to [5.2 FAQ](#) for installation steps.

1.2 Product Overview

Mix to the max. The all-in-one mini-mx video enables accessible professional multi-source video productions with cameras, laptops and multiple audio sources.

For live presentation and streaming, do it all with ease from the unique and fully featured mini-mx..

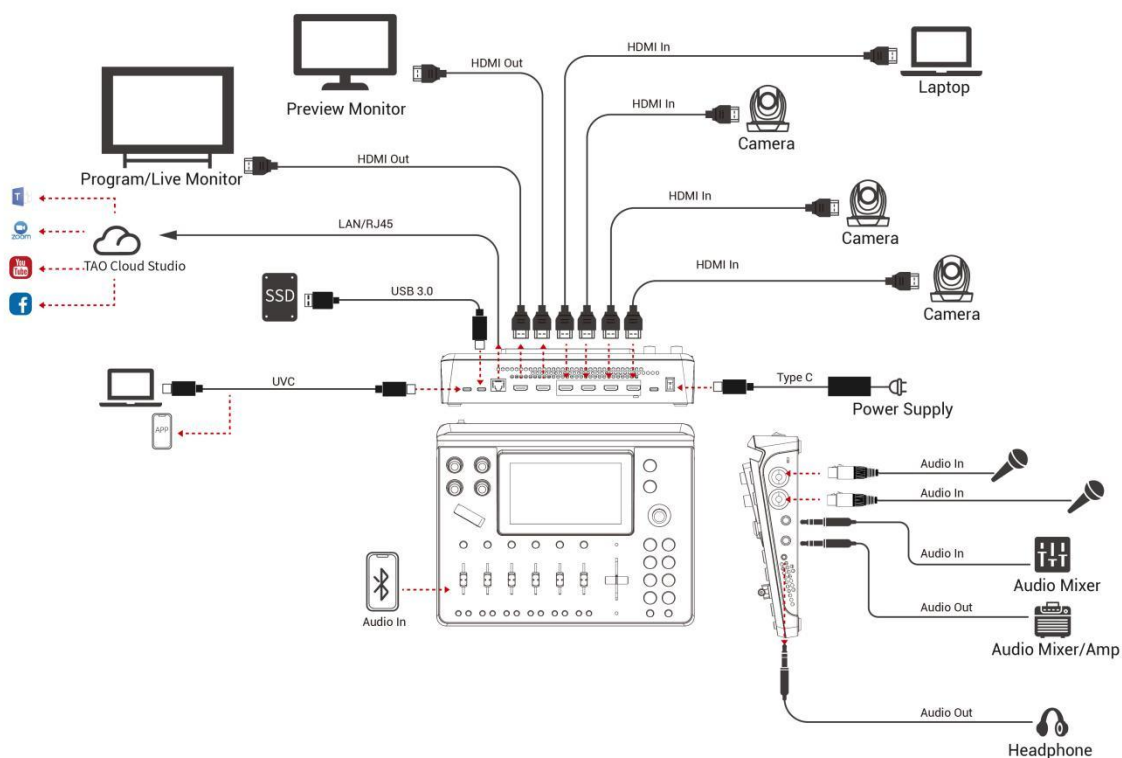

Note:

1. If use 2 platforms for streaming at the same time, please ensure the upstream bitrate is not less than 100Mbps.
2. For upstream bitrate lower than 100Mbps, it is recommended to use 1 platform.
3. To stream to multiple platform, it is recommended to use TAO Cloud Studio.

1.2.1 Key Features

- 4K multi-channel streaming video mixer
- Built-in 5.5 inch touch screen for menu operation
- Quad HDMI 2.0 inputs, resolutions up to 4K@60
- Dual HDMI 1.3 outputs for monitoring of multi-window PREVIEW and PROGRAM
- Dual MIC in, one Line-in, one Bluetooth in, dual audio out
- Mix for HDMI embedded and external audio
- One-key recording. Recording capacity of hard drive is up to 2T
- Support simultaneous streaming to 2 live streaming platforms via RTMP(S)
- Support multi-layer overlay, layer scaling and cropping
- 15 switching effect modes
- 5-direction joystick for controlling up to 4 PTZ cameras
- Save and store up to 16 scene presets. One-click for preset recall
- Support Chroma Key
- One-key quick switch between portrait and landscape screen
- Support web control, compatible with mobile devices and computers, compatible with multiple operating systems

1.2.2 Front Panel



<p>1 Audio Volume Controls</p>	<p>Embedded audio volume adjustment for HDMI 1~4 inputs. Check audio status on touch screen.</p>
<p>2 Adjuster</p>	<ul style="list-style-type: none"> ● Size adjustment for Layer A and Layer B. ● Zoom in/out for PTZ control.
<p>3 Layer Selection Buttons</p>	<ul style="list-style-type: none"> ● Indicate Background, Layer A, Layer B, Logo, Overlay and Text from left to right. ● No button light for closed layer. ● Single Click: Single click to add layer to Preview window. Button illuminated blue indicates enabled and selected state, which allows you to use Button 1~8 to select correspond layer signal or source. Button illuminated green indicates enabled but un-selected state. Click the button illuminated blue again to close the opened layer. ● Long Press: Long press Button Background to enter Media Management Interface. Long press Button Layer A/Layer B/Logo/Overlay to enter Layout Interface.

<p>4 Channel Fader</p>	<p>Control audio volume level for MIC1、MIC2、Line-in、Bluetooth、PREVIEW、PROGRAM from left to right.</p>
<p>5 Listen & Mute Buttons</p>	<ul style="list-style-type: none"> ● Listen Button: Audio management for monitoring port. Button illuminated green allows users to monitor the audio from a channel ; no button light indicates monitoring function is OFF. ● Mute button: Mute that channel at Program port. When a channel is muted, the button will be illuminated red; no button light indicates the channel is ON at Program port.
<p>6 T-Bar</p>	<p>Preview and Program views can be transitioned manually by pushing the T-bar bidirectionally from the top to the bottom or from bottom to top.</p>
<p>7 Page Up</p>	<p>Press to return to previous operation interface or page.</p>
<p>8 Page Down</p>	<p>Press to enter the next page.</p>
<p>9 Button 1~8</p>	<ul style="list-style-type: none"> ● Correspond to 1~8 items in MENU. ● Button 1~4 : Used as HDMI input switch button if Layer A or Layer B is selected or source selection button when selecting other layers. ● Button 5~8 : Used as source selection button when selecting layers except Layer A and Layer B. ● No button light for no input. When there is an input signal, button will be illuminated white. When the signal is in Preview, the button will be illuminated green; when the signal is in Program, the button will be illuminated red.
<p>10 5-Direction Joystick</p>	<ul style="list-style-type: none"> ● Move Up/Down/Left/Right: Position adjustment for layer; set pan, tilt and zoom for PTZ camera. ● Press: Press joystick to enter full screen if Layer A or Layer B is selected and press it once more to to restore; push joystick to enter Controlling PTZ Camera when under PTZ control.
<p>11 MENU Button</p>	<ul style="list-style-type: none"> ● Single Click: In Main Interface, click to enter MENU; in MENU, click to enter Main Interface ; in interface except MENU and Main Interface, click to return back to previous page.

	<ul style="list-style-type: none"> ● Long Press: In interface except Main Interface, long press to enter Main Interface; in Main Interface, long press to lock buttons and touch screen with MENU Button illuminated red; long press MENU Button again to unlock.
12 ON AIR	<ul style="list-style-type: none"> ● Press to start or end streaming. ● Check streaming status on LCD screen: steady red shows ON AIR, flashing red shows unstable network, unlit shows finished state.
13 5.5-inch Touch Screen	For menu operation and multi-view window monitoring.

1.2.3 Interface Panel

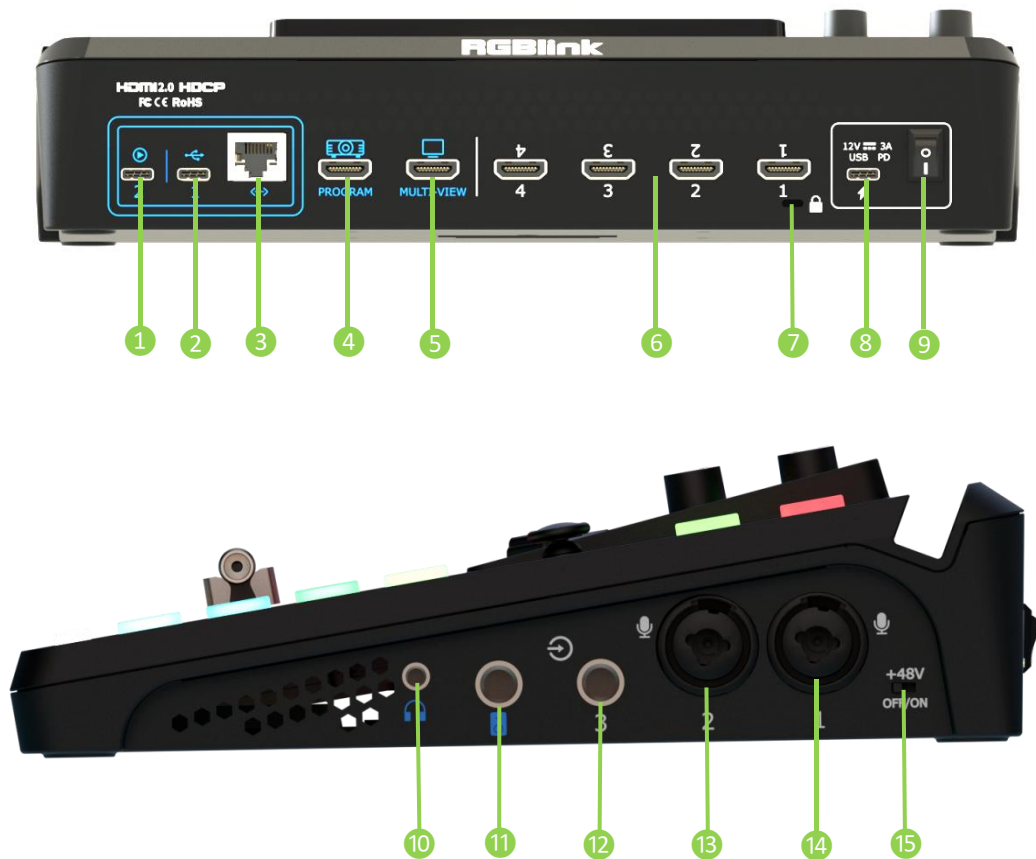

① UVC	Recognized as USB webcam to connect computer or mobile phone for streaming or video conference.
② USB-C	<ul style="list-style-type: none"> ● Insert SSD or U disk for recording. ● Insert a U disk to import audio, video and graphic files. ● Use with USB-C cable provided to share network with mobile phone. (Refer to Smartphone Tethering)
③ Ethernet Port	Achieve network connection and camera control connection for streaming, remote control, upgrade and camera signal transmission.
④ PROGRAM	PROGRAM output port. Default to output real-time scene, can set as Multi-view Preview or Test Pattern.
⑤ MULTI-VIEW	MULTI-VIEW output port. Default as multi-view preview output, can set as Program or HDMI 1~4.
⑥ 1~4 HDMI in	Four HDMI input ports support 4K resolution and downward compatible with all resolution.
⑦ Locking Hole	Use with T-lock to fix the device.
⑧ USB-C Power Port	PD protocol, 12V, 3A.
⑨ Power Switch	Rocker switch to power on or off device.
⑩ Headphone Output	3.5mm mini-jack for listening each analog input and HDMI input.
⑪ 6.35mm TRS Jack	Balanced TRS audio output jack.
⑫ Line-in	Balanced 6.35mm TRS jack to connect to PC, mobile phone or audio console.
⑬ MIC in 2	XLR+TS input port to connect to microphone.
⑭ MIC in 1	<ul style="list-style-type: none"> ● XLR+TS input port to connect to microphone. ● 48V Phantom Power supported.
⑮ +48V DIP Switch	<ul style="list-style-type: none"> ● 48V Phantom Power switch. ● Defaults to OFF.



Warning:

Except condenser microphones that require phantom power, please **Turn Off** phantom power switch when connecting other devices.

1.2.4 Dimension

Following is the dimension of mini-mx for your reference:

280.0mm x 222.6mm x 63.5mm.

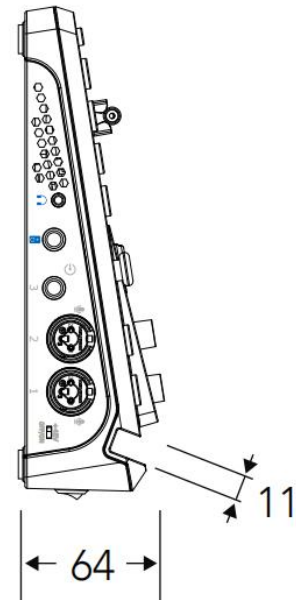
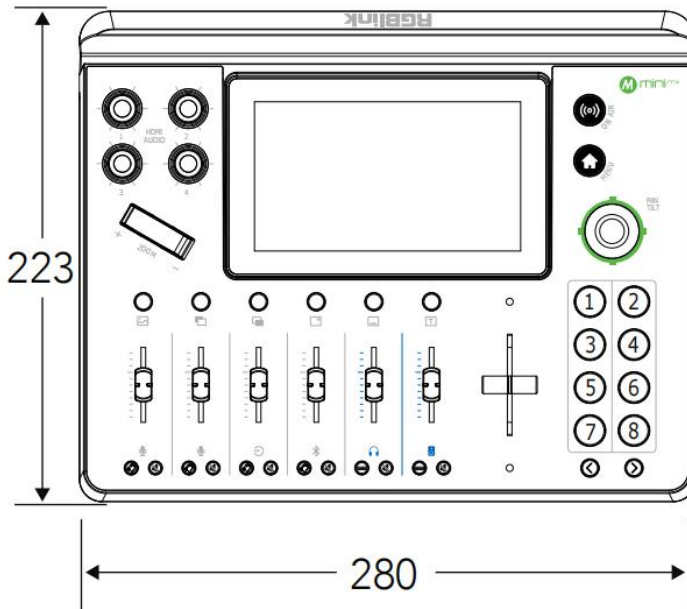
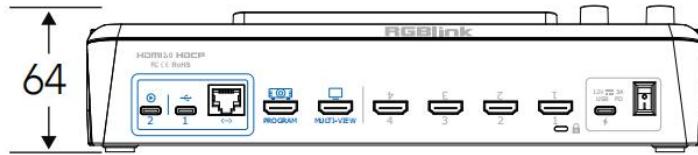

Chapter 2 Install Your Product

2.1 Connecting HDMI Input

Users can use any camera, computer or other HDMI device as the input source of the mini-mx.

mini-mx supports up to 4 sources of different formats and resolutions at the same time via 4 HDMI ports, and **4 HDMI inputs support up to 4K@60Hz**. If users are using interlaced signal, mini-mx supports de-interlace through HDMI 1 automatically.

Users can see the input views on the mini-mx screen when there is active signal plug in. Connect mini-mx to a monitor with HDMI output interface to see PVW views and output resolutions.



Warning:

The HDMI cable is not included in the mini-mx package and needs to be purchased separately. Some camcorders use a mini HDMI port, you need to buy a mini HDMI-HDMI cable separately when you use these camcorders.

2.2 Connecting HDMI Output

Users can use HDMI cables to connect MULTI-VIEW and PROGRAM output interfaces to a monitor with an HDMI input interface so as to check PVW and PGM views in real time.



The default output of MULTI-VIEW port is multi-screen Preview view, so user can see the audio and video conditions of all input signal sources, check current status of each function of mini-mx and see the Preview view.

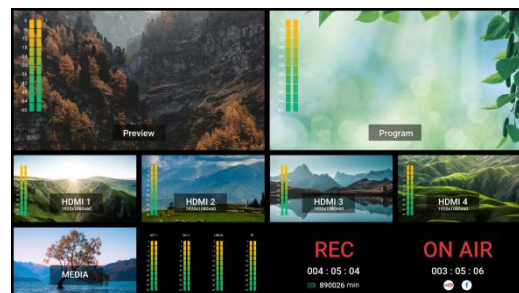

Users can switch screen mode and select HDMI output resolution by pressing **【OUTPUT】** on the main menu.

MULTI-VIEW supports output in multi-view, HDMI 1~4 signal source or program.

PROGRAM supports output in multi-view, program and test pattern.

2.3 Connecting Microphone and External Monitoring Devices

On the right panel of mini-mx, there are **five audio jacks in total**.

mini-mx features **THREE high-quality audio input jacks** on the right panel, TWO of which adopt XLR+TS jacks (MIC in 1 supports 48V phantom power). The other one adopts Line-in 6.35mm TRS jack, which can be directly connect to the mobile phone, PC and console.

mini-mx comes with **TWO audio output jacks** on the right panel. One adopts 3.5mm mini-jack, which can be directly connect to the headphone for audio monitoring. The other line PGM output jack adopts 6.35mm TRS jack, which is for connecting speakers.

For laptops or mobile phones with no audio output ports, mini-mx provides a **built-in Bluetooth module**. Users can connect to devices with Bluetooth function to input high-quality audio signals in real time. (More details please refer to [Bluetooth](#))

In addition, the **four HDMI input ports all support embedded audio**. Turn on AFV, the audio follows the video switch to perform a soft gradual transition when video is switched.

There are 8 audio inputs in total, which can be controlled via operation board to achieve audio mixing and monitoring. (More details please refer to [Audio](#))



Warning:

1. Noise may occur during plugging, unplugging and audio tuning. When connecting audio output port (main output and monitor port) to the speaker, if the speaker is powered on, it may be damaged during unplugging process. Therefore, please power on speaker after connection, and power off it first before unplugging.
2. MIC supports access to wireless microphone with a 3.5mm female to 6.5mm male single-track adapter. LINE supports access to wireless microphone with a 3.5mm female to 6.5mm male dual-track adapter.
3. Balanced signals can only be input through MIC 1 or MIC2; stereo signals can only be input through LINE IN.

2.4 Connecting USB for Streaming and Recording

The USB port **labeled number 2** is for video capture, which allows users to capture videos to computer and the captured video content can be streamed to Facebook, YouTube, Zoom, Twitter and other streaming media platforms via a third-party Video Media Player software like OBS.

Insert a U disk to the other USB 3.0 port **labeled number 1** by USB 3.0 cable to perform recording. mini-mx supports recording streaming media content to an external USB storage device, such as U disk or SSD. The SSD storage can reach up to 2T, and the USB storage can support up to 64G. The supported format is exFAT.

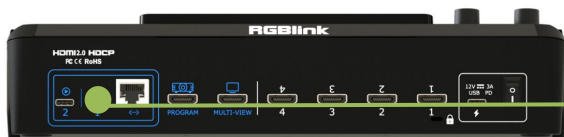

Warning:

1. For U disk, please use one with USB 3.0 port.
2. For SSD, please check if it needs extra power supply.
3. OTG cable only for file transfer cannot be used for streaming.
4. For dual-channel streaming, or use UVC output/recording simultaneously, the touch screen may get sluggish.
5. USB-C ports adopts USB 3.1 data transmission protocol.

2.5 Connecting Router

Connect router and mini-mx with CAT6 cable. Click **MENU > SETTING > NETWORK > Turn off DHCP** to set IP address of mini-mx. When connecting mini-mx and the router, the IP address of mini-mx must be in the same LAN as the router.



2.6 Plugging in Power

RGBlink mini-mx is packaged with a PD power adapter (power cable included) , check the power supply standard used in your country or region before power connection.

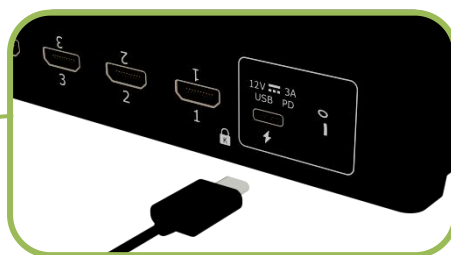

Connect mini-mx to power plug by the link cable



Warning:

The Power Supply included with mini-mx is the recommended power supply to use with the device. Power supply should meet the following requirements:

1. Support PD "Fast Charge" capability.
2. Interfaces are the same as the adapter provided.
3. The power supply is rated for a minimum of 36W.

2.7 Turning on Your mini-mx

After mini-mx is connected to power supply, push the DIP Switch on the rear panel, the device will show mini-mx logo and then enter to the operation interface.



Chapter 3 Use Your Product

After the above steps are completed, users can use mini-mx to do the following.

3.1 Main Interface

As shown below, once powering on mini-mx, the 5.5 inch display will show mini-mx logo and then come into Main Interface. Operator can refer to the description below.

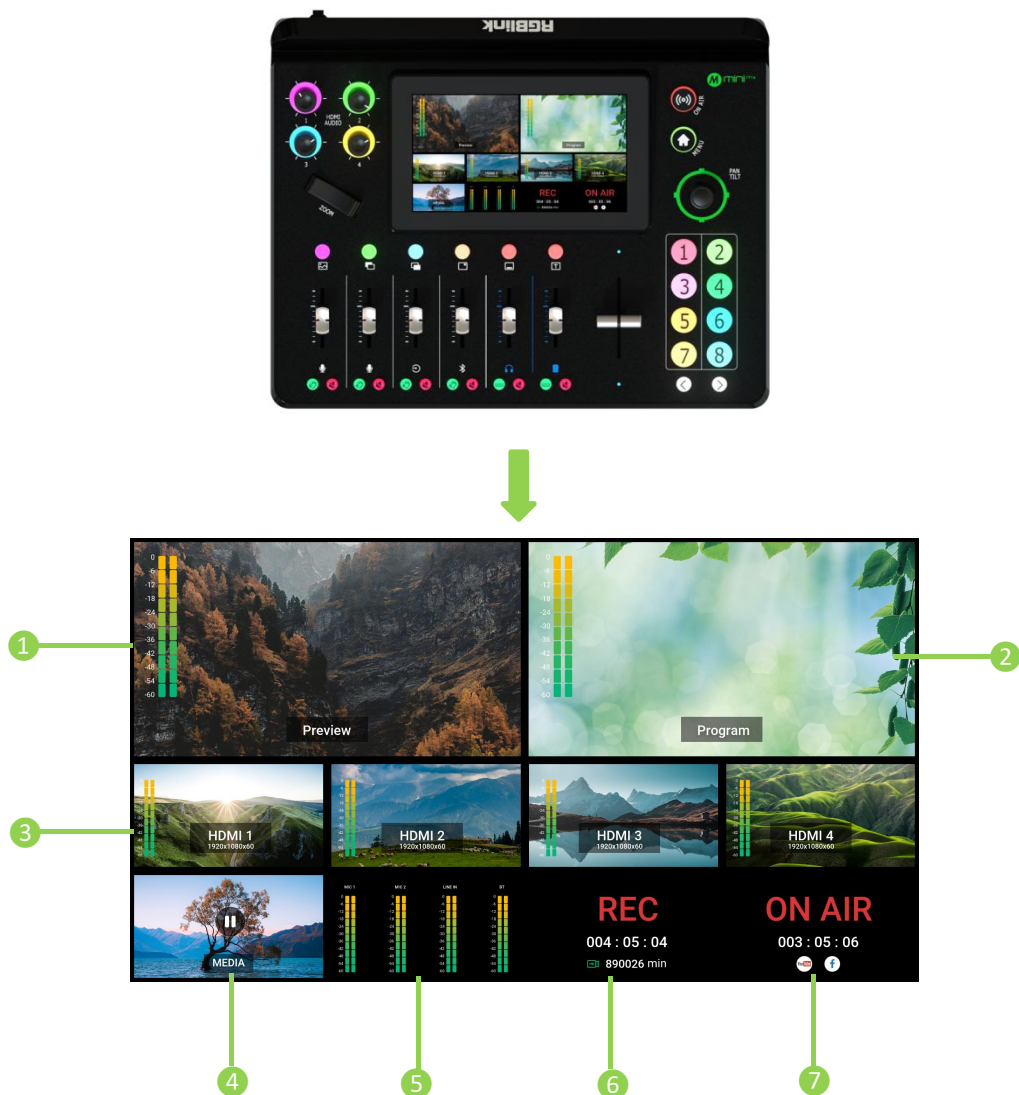

Area	Description	Operation	
1 PREVIEW	Show Preview screen and audio meter	Single Click	Enter Editing Interface.
		Double Click	Enter full screen mode and double click again to exit.
		Long Press	Choose to save current scene or not (Click Saving and Loading Scenes for more details.)
2 PROGRAM	Show Program screen and audio meter	Single Click	<ul style="list-style-type: none"> •Enter Saving and Loading Scenes. •Enter Saving and Loading Scenes under full screen mode.
		Double Click	Enter full screen mode and double click again to exit.
		Long Press	Enter Switch Effect Setting .
3 Source Selection	Show HDMI 1~4 signals and audio meter	Single Click	If use PTZ as HDMI input source, single click to select PTZ, use Adjuster and Joystick can achieve PTZ control. Push Joystick to enter Controlling PTZ Camera .
		Double Click	Switch to current signal in PREVIEW.
		Long Press	Display current signal to PROGRAM.
4 Media	Show media sources	Single Click	Select media signal source.
		Double Click	Enter Media Management Interface.
		Long Press	Display current signal source to PROGRAM.
5 Audio Monitoring	Monitor 3 analog audio inputs (MIC1 、 MIC2 、 Line-in) and 1 Bluetooth audio input	Single Click	Enter Audio .
		Double Click	Enter Audio .
		Long Press	Enter Audio .
6 Recording	Check recording duration and remaining recording duration	Single Click	Start or end recording.
		Double Click	Enter Recording .
		Long Press	Start or end recording.
7 Streaming	Check streaming duration and status	Single Click	Start or end streaming.
		Double Click	Enter Streaming .
		Long Press	Start or end streaming.

3.2 MENU

There is a 5.5" touch screen on operation board, through which most operations can be done.

Push MENU button in Main Interface and the LCD screen will quickly enter MENU.



As shown in the figure above the UI style on the touch screen is similar to current smart phone operating interface.

The first-level menu is in icon. Users can quickly enter the corresponding function management interface by tapping the corresponding icon.

8 functions are available in MENU, including **EFFECTS**, **LAYOUT**, **PTZ**, **SCENE**, **CHROMA KEY**, **AUDIO**, **OUTPUT** and **SETTING**.

3.3 Editing Interface

Click PREVIEW Window on Main Interface or tap  icon to enter Editing Interface.

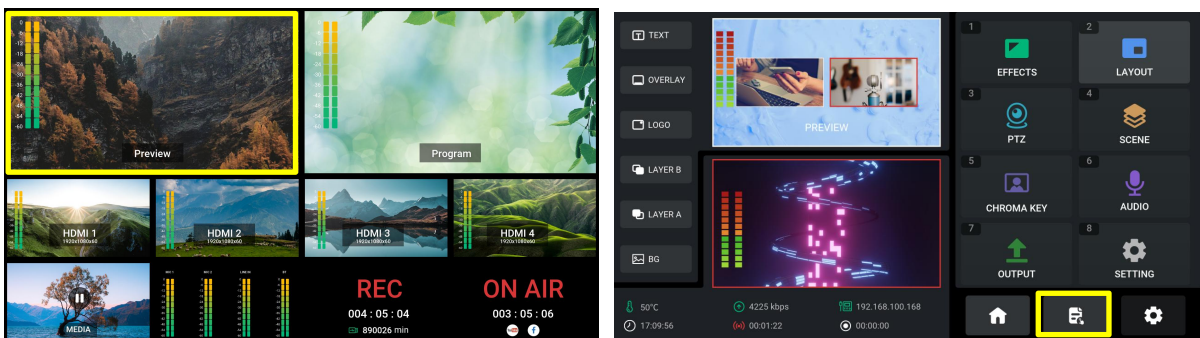



<p>1 PREVIEW</p>	<ul style="list-style-type: none"> • Preview screen and audio meter monitoring area, which can be used for enabling/disabling layer, editing size & position, signal, source, PTZ control, etc. • Long Press: Choose to save current scene or not (Click Saving and Loading Scenes for more details.) • Double Click: Enter full screen mode and double click again to exit. 						
<p>2 Layer Selection</p>	<ul style="list-style-type: none"> • For layer not been selected before, click correspond icon to enable. • Icon in green indicates enabled status. Icon in blue indicates editing status. • Click icon in blue (editing status) once more to close the opened layer. 						
<p>3 PROGRAM</p>	<ul style="list-style-type: none"> • Program screen and output audio meter monitoring area. • Single Click: Enter Saving and Loading Scenes. • Long Press: Enter Switch Effect Setting. • Double Click: Enter full screen mode and double click again to exit. (Under full screen mode, you can do the followings: 1. Click PGM window to enter Saving and Loading Scenes; 2. Long press to choose whether to save current scene or not, tap “YES” to enter Saving and Loading Scenes.) 						
<p>4 Status Display</p>	<table border="1"> <tr> <td> 50°C : Temperature</td> <td> 4225 kbps : Bit Stream</td> <td> 192.168.100.168 : Network State& IP</td> </tr> <tr> <td> 17:09:56 : Time</td> <td> 00:01:22 : Streaming Status</td> <td> 00:00:00 : Recording Status</td> </tr> </table>	50°C : Temperature	4225 kbps : Bit Stream	192.168.100.168 : Network State& IP	17:09:56 : Time	00:01:22 : Streaming Status	00:00:00 : Recording Status
50°C : Temperature	4225 kbps : Bit Stream	192.168.100.168 : Network State& IP					
17:09:56 : Time	00:01:22 : Streaming Status	00:00:00 : Recording Status					

<p>5 Icons</p>	<p>Press to Enter Main Interface, Editing Interface or MENU Interface.</p>
<p>6 Signal Monitoring & Source Selection</p>	<ul style="list-style-type: none"> • Correspond to Button 1~8 one-by-one. • 1~4 windows for HDMI 1~4 signal monitoring, tap Window 1~4 or use Button 1~4 to switch signal. If use PTZ as HDMI input source, use Adjuster & Joystick to control PTZ, and push joystick to enter Controlling PTZ Camera. • 5~8 windows for source selection, use U disk to import sources. Single click to choose sources available. Single click, long press or double click window with no source to enter Media Management Interface for source selection.

3.4 PIP (Picture-in-Picture)

mini-mx defaults to single-screen switching. If you need to use PIP, push MENU Button to enter Main Menu, tap **【LAYOUT】** in MENU or push Button 2 to enter the setting interface.



PIP layout allows multiple windows to be displayed simultaneously on a single screen, offering users a perfect platform to check multiple video contents at the same time. The PGM Program is display on the full screen, and at same time the PIP video source will be displayed in the PGM window as an inset window.

RGBlink offers 7 layout options. If the Layout **【6】** is selected, use the Adjuster to achieve a better view of the picture ratio.

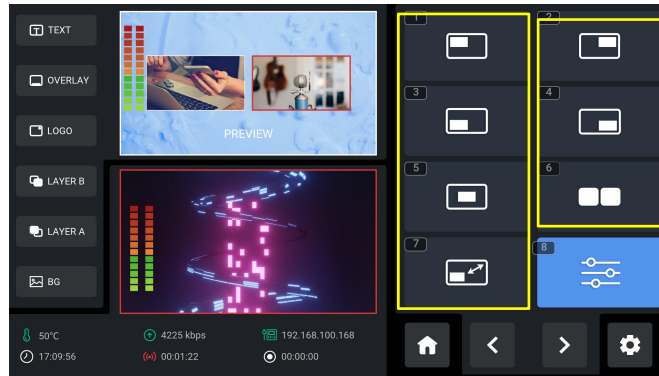

Click Option **【8】** Advanced Setting to do more specific parameter settings for layer cropping and scaling. As shown in the figures below, use joystick to choose item and then do settings by using slide bar or adjuster.

In **Layer Scaling** interface, users can adjust Width, Height, Horizontal Position, Vertical Position and set Zoom ratio.

In **Layer Cropping** interface, Width, Height, Horizontal Position and Vertical Position can be set.

Click **Reset** at the bottom to clear wrong settings so as to restore to the default values.

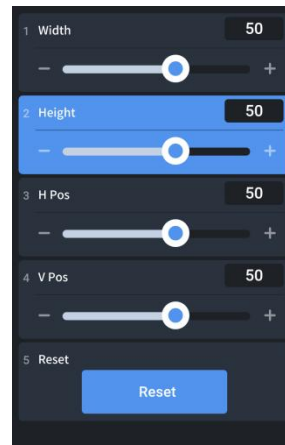

3.5 Adding Layers

mini-mx allows users to import layers, such as BACKGROUND, LOGO, OVERLAY, etc. You can refer to Video Diagram below for application.

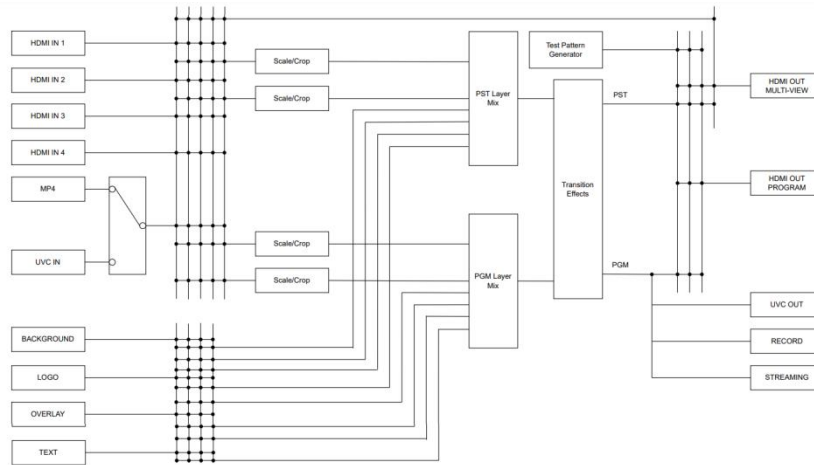

3.5.1 Layer Storage Path

Use a U disk to import layers, such as BACKGROUND, LOGO, OVERLAY, etc.

Before importing layers, please create folders for layer storage in the U disk.

Create Folders Automatically:

1. Insert a U disk into USB interface labeled number 1, reboot mini-mx or enter BACKGROUND/LOGO/OVERLAY interface.



2. Wait for mini-mx to recognize available files. Figure below indicates no files available in U disk.

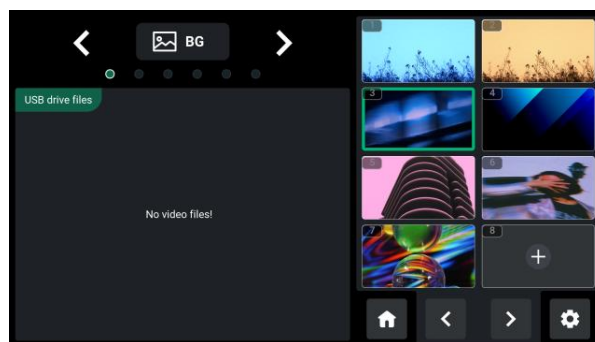

3. If there are no available files, the USB flash drive will automatically create a folder named

mini-mx, with **audio**, **image**, **video** folders included. The **image folder** includes three sub-folders: background, logo and overlay.



 **Tips:** Layers should meet the following requirements:

- 1. BACKGROUND:** 1) no space and symbols in picture name; 2) jpg, png format (32-bit depth) or bmp (24-bit depth), resolution within 1920x1080, subject to the actual output resolution; 3) picture size should be consistent with the resolution.
- 2. LOGO:** 1) no space and symbols in picture name; 2) png format (32-bit depth), resolution within 1920x1080, subject to the actual output resolution.
- 3. OVERLAY:** 1) no space and symbols in picture name; 2) png format (32-bit depth), resolution within 1920x1080, subject to the actual output resolution.
- 4. Audio:** in mp3 format.

4. Store materials in corresponding folder.

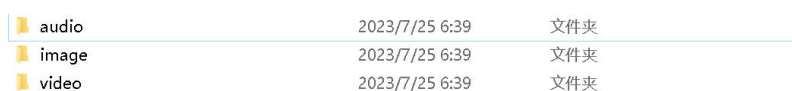

Create Folders Manually:

1. Create a folder name mini-mx by yourself.
2. Create **audio**, **image**, **video** folders respectively in mini-mx folder.
3. Create three sub-folders **in image**: background, logo and overlay.
4. Store materials in corresponding folder.

audio	2023/7/25 6:39	文件夹
image	2023/7/25 6:39	文件夹
video	2023/7/25 6:39	文件夹

Tips:

Go to RGBlink website (<https://rgblink-web.azurewebsites.net/productsinfo.aspx?id=252>) > mini-mx > download mini-mx_material pack.

3.5.2 Adding Background

1. Insert a U disk into the USB port labeled number 1 to import background sources.



2. Tap BACKGROUND in Layer Selection Area or Source Selection Area, long press BACKGROUND Button to enter background management interface.

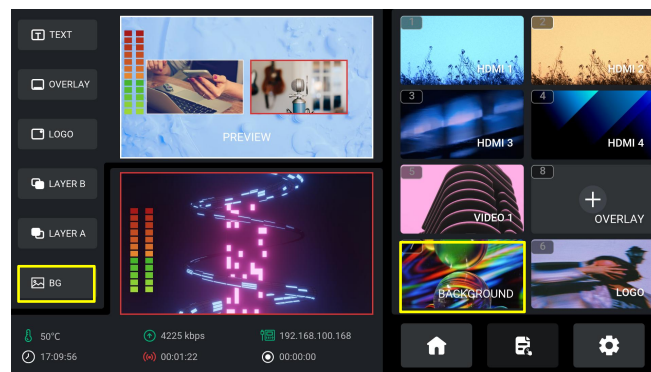

3. Tap "+" and then choose background source in U disk to add it to Source Selection Area. Long press the added source for deletion.

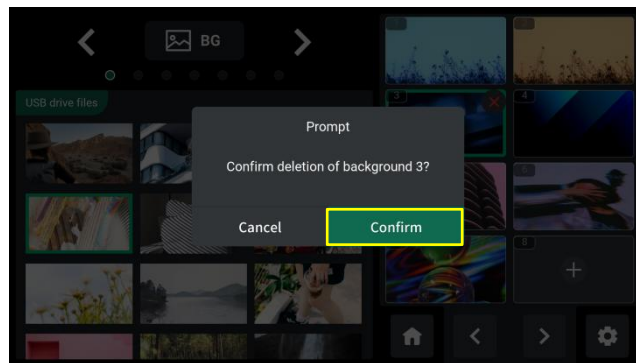
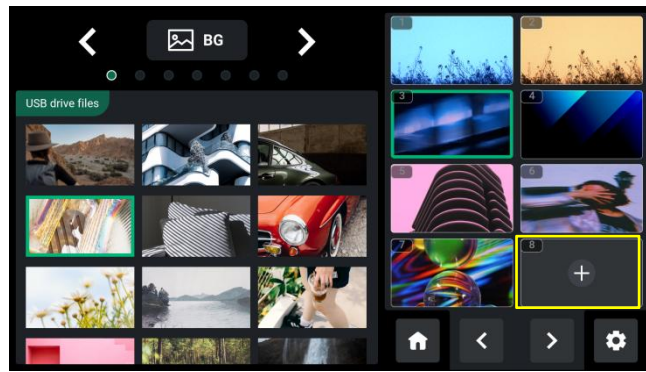

4. Push Background Button on the front panel to add background to PREVIEW window.



5. In Editing Interface (multi-screen interface), push Button 7 to quickly enter background management interface for background picture replacement.

3.5.3 Adding Layer A

1. Push Layer A Button on the front panel to edit Layer A. This operation simultaneously enables Layer A.



2. Push Button 1~4 on the front panel to select the input.



3. Use the Adjuster on the front panel for zoom-in and zoom-out of Layer A and the Joystick to quickly adjust horizontal and vertical position. Push joystick to full screen mode, then push it again to restore to the size and position last set.



4. Long press Layer A/Layer B/Logo/Overlay Button to enter Layout Selection Interface. Or you can tap LAYOUT icon in MENU or push Button 2 to enter Layout Selection Interface. Select

required layout for Layer A and display it on the background. Click Option 【8】 Advanced Setting to do more specific parameter settings for layer cropping and scaling.

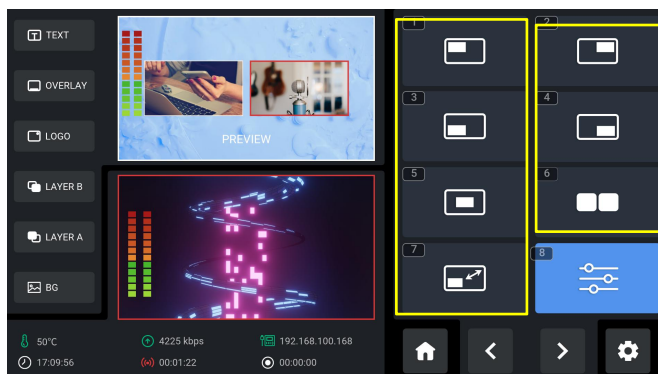

3.5.4 Adding Layer B

1. Push Layer B Button on the front panel to edit Layer B. This operation simultaneously enables Layer B.



2. Push Button 1~4 on the front panel to select the input.



3. Layout Selection, Size & Position Adjustment, Layer Cropping & Scaling, please refer to operations in [Adding Layer A](#).

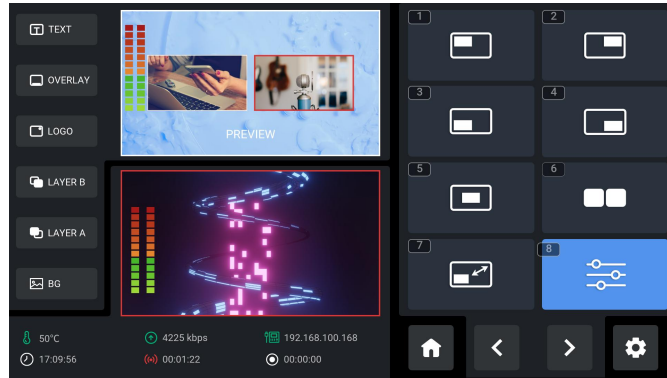

3.5.5 Adding LOGO

1. Insert a U disk into the USB port labeled number 1 to import LOGO sources.



2. Tap LOGO in Layer Selection Area or Source Selection Area to enter LOGO management interface.

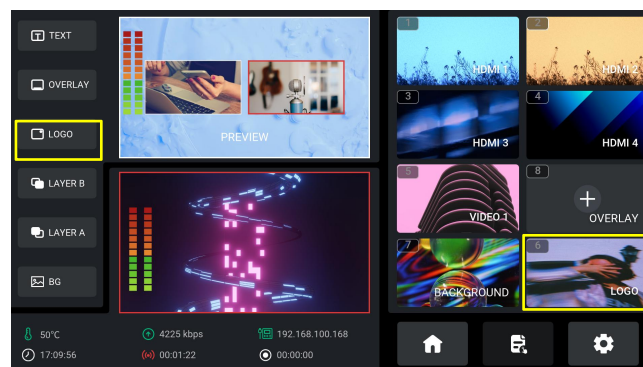

3. Tap "+" and then choose logo source in U disk to add it to Source Selection Area. Long press the added source for deletion.

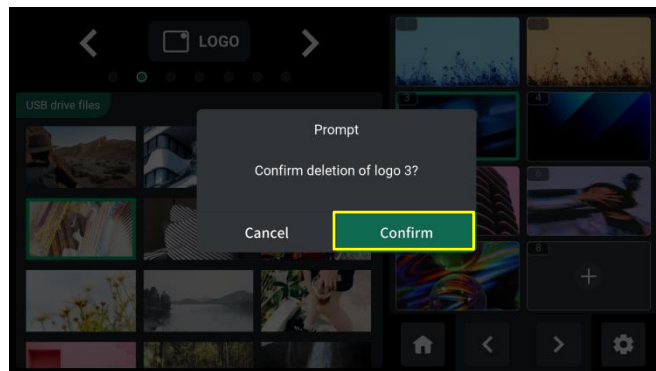
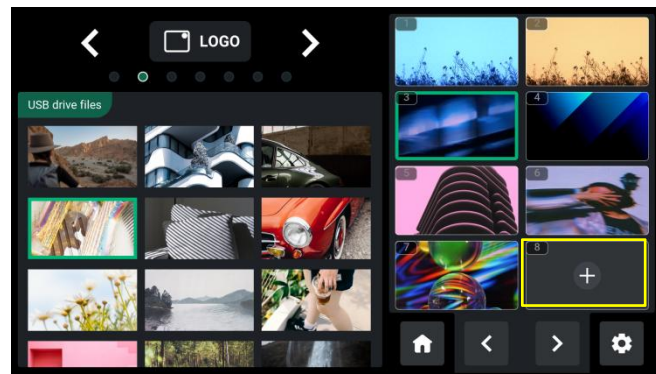

4. Push LOGO Button on the front panel to enable the function.



5. Same as operations in Adding Layer A and Adding Layer B, choose required layout in LAYOUT interface and use the Joystick to quickly adjust horizontal and vertical position of LOGO.

3.5.6 Adding Overlay

1. Insert a U disk into the USB port labeled number 1 to import overlay sources.



2. Tap OVERLAY in Layer Selection Area or Source Selection Area to enter OVERLAY management interface.

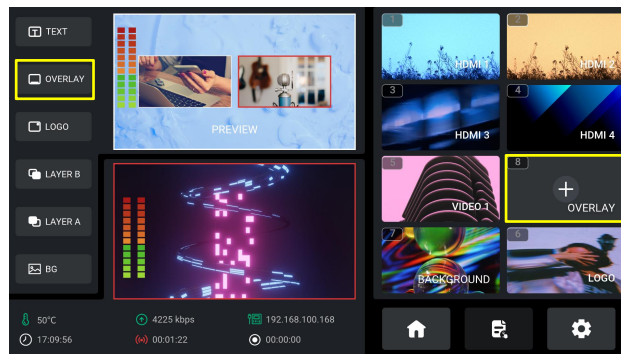

3. Tap "+" and then choose background source in U disk to add it to Source Selection Area. Long press the added source for deletion.

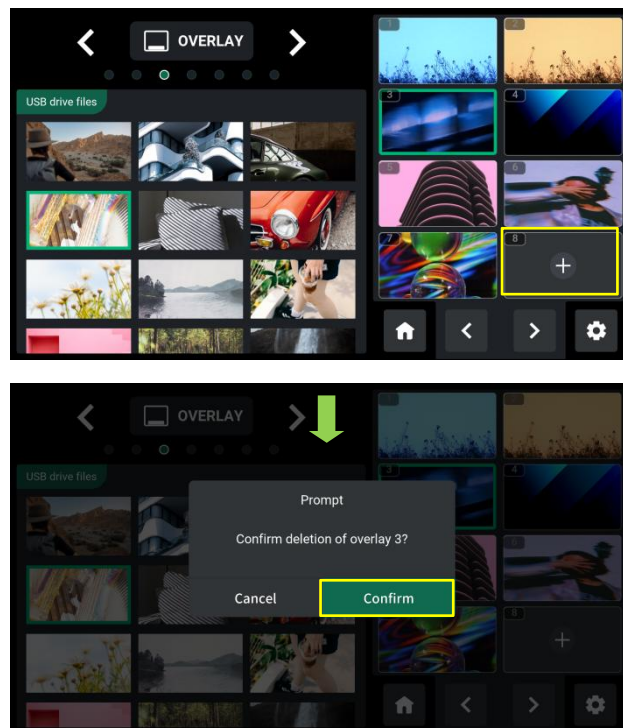

4. Push Overlay Button on the front panel to enable the function.



4. Same as operations in Adding Layer A and Adding Layer B, choose required layout in LAYOUT interface and use the Joystick to quickly adjust horizontal and vertical position of OVERLAY.



3.5.7 Adding Scoreboard



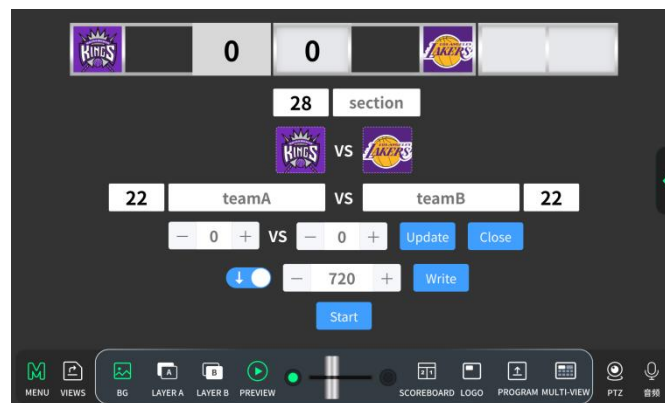

A scoreboard layer can be added to the PGM program output window via mini-mx web interface. The scoreboard can record the score of a game in real time, which is commonly used in sports broadcasts, such as football, basketball, or other competitive sports matches. mini-mx' s scoreboard function allows viewers to stay updated on the current score at any time.

Click  to enter the following interface.



Operation is as follows:

1. : Enter First Half or Second Half and set its corresponding Font Size so as to allow spectators and participants to check the scoring situation of the game in different time periods. After setting, click  to save.

2.  : Click to import images as logos for two teams.
 3. : Enter names for two teams and set its corresponding Font Size. After setting, click **Update** to save.
 4. : Click "-" to decrease scores in real time and "+" to increase. After setting, click **Update** to save.
 5. **Update**: Click to synchronize the settings.
 6. **Close**: Click to cancel scoreboard display on PVW Preview window and click once again to display the scoreboard on PVW Preview window.
 7. : Enter the Time Duration of the game (unit: seconds), click **Write** and then **Start** to start timing. Click **Stop** to stop timing.  indicates to decrease 1 second in real time. Click to switch to  to increase 1 second in real time.
- Complete the above settings, then click  to check the scoreboard layer placed on PGM window.

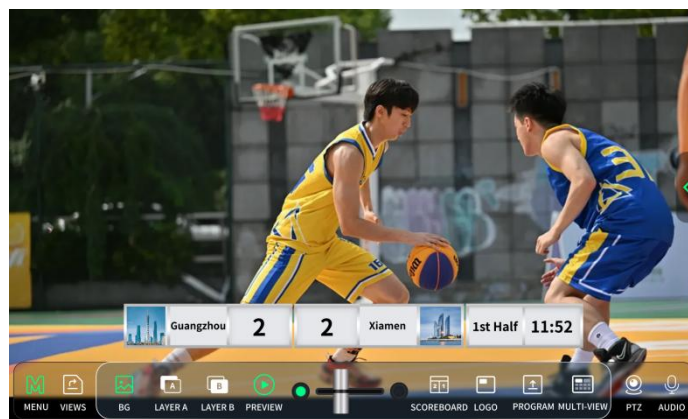

3.6 Chroma Key

mini-mx supports matting, that is, removing the pure color background and overlaying it on another signal to realize the application of virtual reality. Push MENU Button to enter Main Menu, tap **【CHROMA KEY】** in MENU or push Button 5 to enter the setting interface.



Users can choose ON or OFF to enable or disable Chroma Key (off by default).

Turn on Chroma Key to perform matting on Layer B by default. Select the background color which is default in green to be removed and make adjustments according to application.

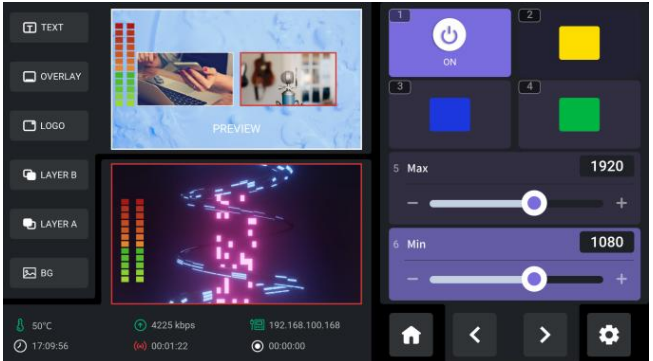

Check the background color required and then use 5-direction joystick to shift options between Max, Min and Margin. Max defaults to 1232, Min defaults to 560, Margin defaults to 200.

3.7 Controlling PTZ Camera

mini-mx can control the camera's lens moving horizontally and vertically, focus and zoom via **IP VISCA protocol** and save the position and zoom information for quick calling.

The PTZ preset of mini-mx not only saves the parameters of the PTZ, but also includes calling the camera, that is, when the preset of PTZ is loaded, the input is switched to the camera signal source at the same time.

Push MENU Button to enter Main Menu.



Tap **【PTZ】** or push Button 3 to enter the interface.

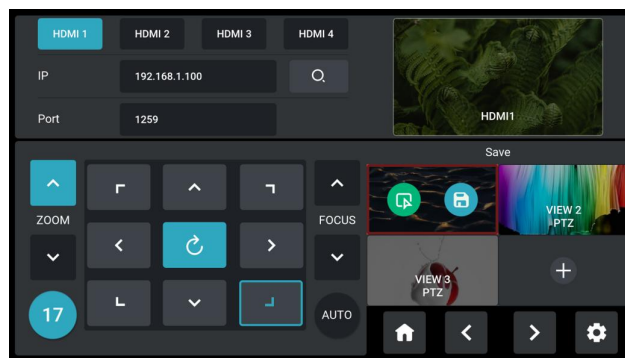

mini-mx supports **simultaneous control of up to four cameras.**

Please check if the port number of the controlled camera is 1259 (It's recommended to use RGBlink vue series PTZ camera). If the port number is not 1259, please enter the port number in PTZ Control interface.

The following operations are explained with examples of using mini-mx to control ONE camera and simultaneously control FOUR cameras.

Example 1: mini-mx controls ONE camera.

- 1) Connect mini-mx and the camera directly via an Ethernet cable;

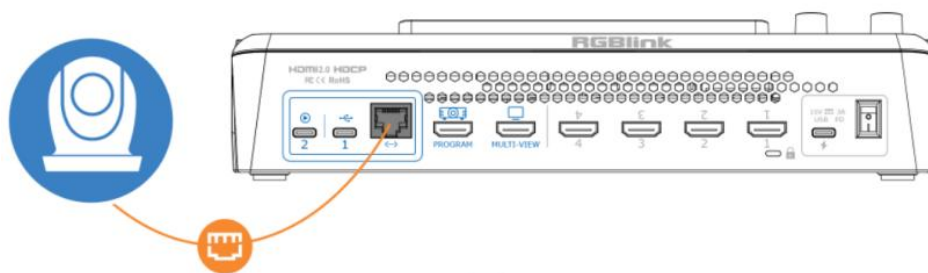

2) Enter IP address of the camera in the following interface and then click "Enter" to save. **(Note:**

The IP address of mini-mx and camera controlled should be in the same LAN.)

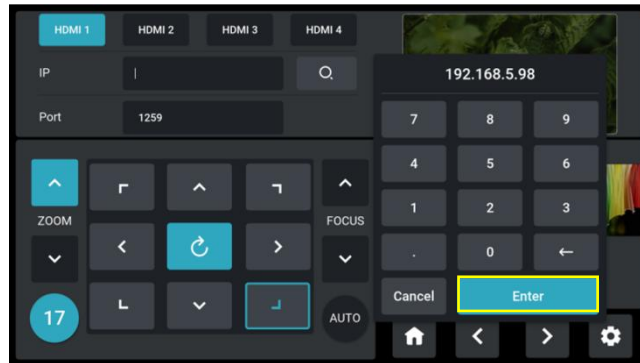

Example 2: Use mini-mx and switch to control FOUR cameras.

1) Use the **ping command** to analyze network connectivity, check if IP address of mini-mx and the cameras are occupied, operations please refer to [FAQ](#).

2) Enter PTZ configuration interface below to set the camera's IP address, then click "Enter" to save. (Make sure IP address has not been occupies, and IP address of mini-mx and camera are in the same LAN.)

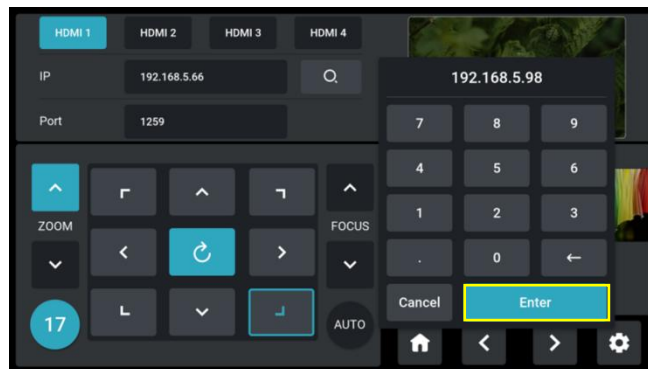

3) Connect camera and computer to the switch.



4) Connect mini-mx and camera to the switch via Ethernet cables (It is recommended to use RGBlink CAT6 cable with order code as 940-0001-00-11-0). Then use mini-mx for PTZ control.



Warning:

1. The computer IP, mini-mx IP and the tested IP must be in the same LAN.
2. It is suggested to use ping command to check IP addresses of four cameras one by one to ensure normal communication.
3. ONLY VISCA via IP protocol is supported. Protocols including NDI PTZ/CGI/HTTP/Pelco-D/Pelco-P are not supported.

5) Tap HDMI 1/HDMI 2/HDMI 3/HDMI 4 to switch camera control interface.

Use Adjuster on the front panel or tap   icon to adjust zoom and focus. Automatic adjustment can be achieved by clicking **AUTO**.

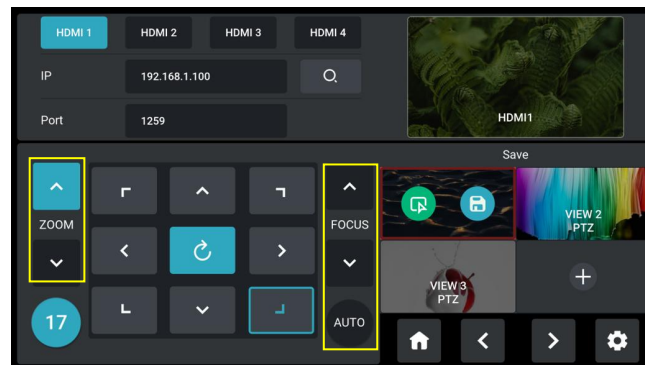

Use Joystick to adjust position of camera.

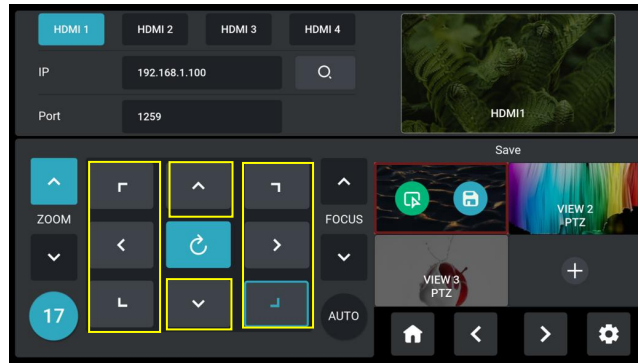

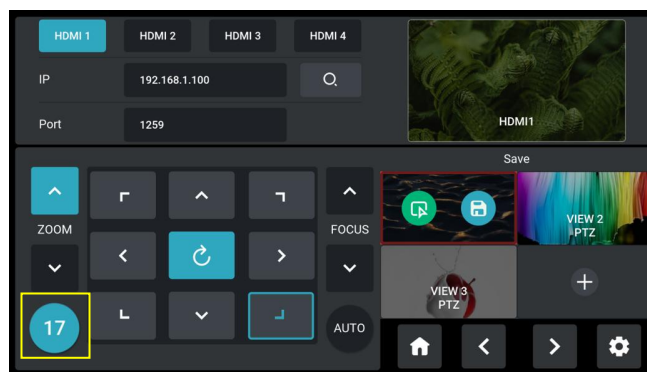

As shown in the figure below, the number displayed indicates the rotation speed of the camera.

Use the Joystick or tap number to adjust rotation speed as 17 (by default), 14, 11, 8, 5 or 2.



Users can create multiple views by setting different camera presets and adjusting parameters such

as zoom. Click  to capture a picture and add it to View. Click  to confirm your selection.

Click  to save the picture captured to View.

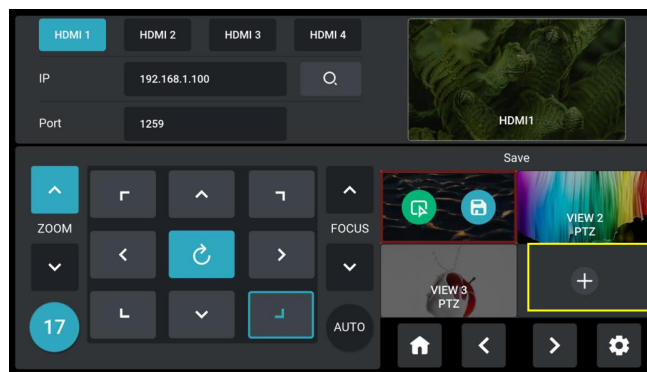

Click  icon to clear wrong settings so as to restore the set parameters to the default values.

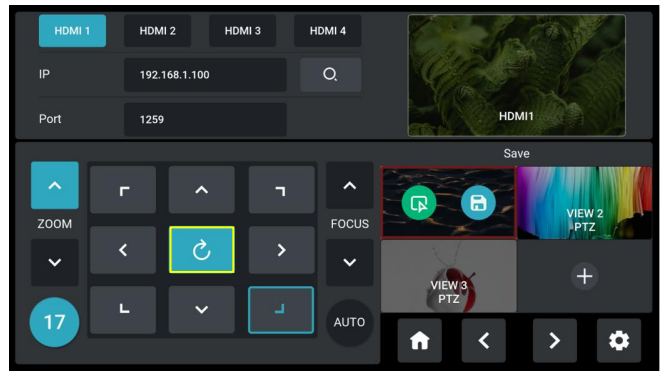



3.8 Saving and Loading Scenes

mini-mx **save presets to Scene in real time**. If users want to quickly load current preset next time, just save it to corresponding scene. The Scene will save all the currently set parameters including Chroma Key, PTZ Presets and more. Therefore when user needs to load a preset, push corresponding Scene for quick calling.

1) After setting the effect, push MENU Button to enter MENU, then tap **【SCENE】** or push Button 4 to enter the interface. You can also long press PREVIEW window or single click PROGRAM window in Main Interface to quickly enter following interface for preset calling or saving.



The preset saving interface is shown as below. Click   for page up or page down.

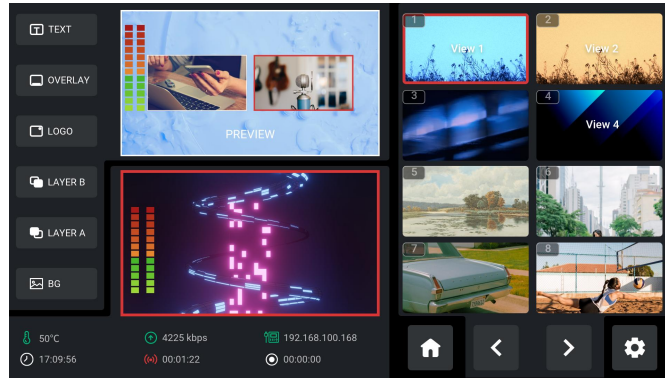

2) mini-mx allows user to save 16 presets in total to the corresponding View 1~16. Long press Preview Window in Editing Interface or Main Interface, and you can choose whether to form a static picture of the current scene and save it or not. mini-mx can save the formed picture to selected area if no scene has been stored before.

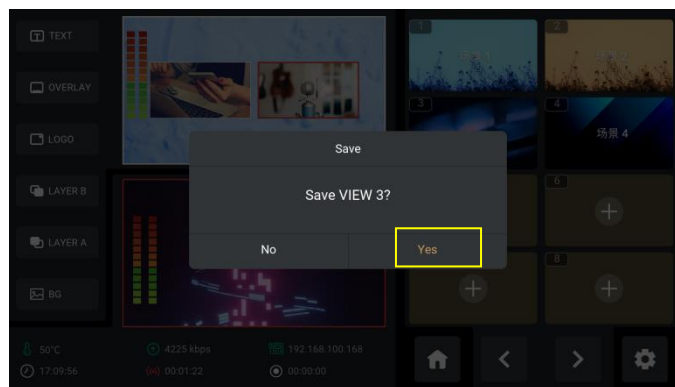

3) Long press certain scene and click "YES" for deletion.

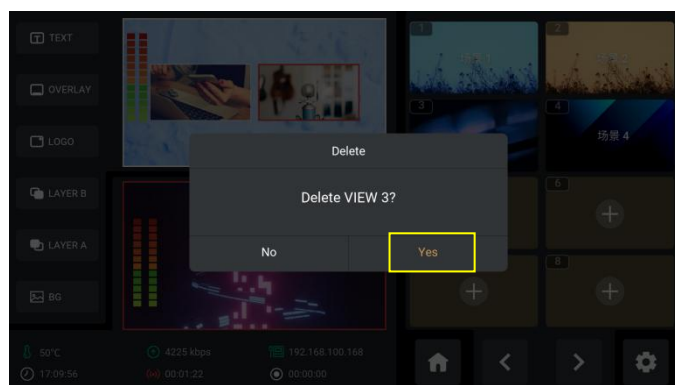

4) Tap the View needed and then double click Program Window for direct loading.

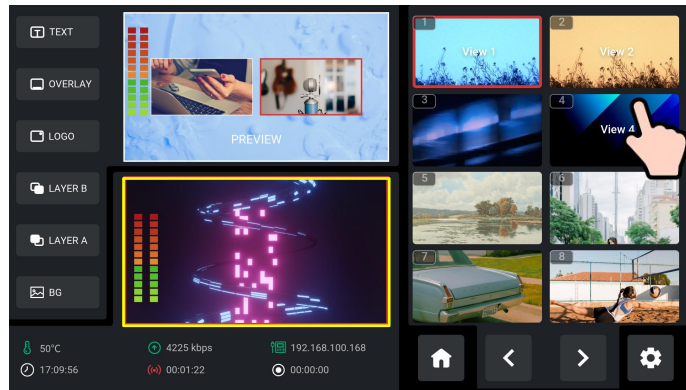

5) If you want the modified preset to be loaded from the Scene, you need to re-save it to the current Scene or a new Scene. Please repeat the above operations of saving scene.

3.9 Video Output

Push MENU Button to enter MENU.

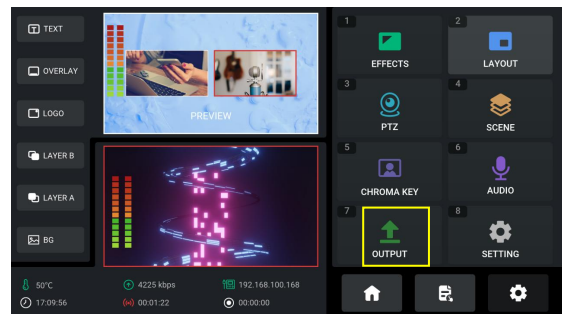

Tap **[OUTPUT]** in MENU or push Button 7 to set parameters for video output.



3.9.1 Multi-view

Click **Multi-view** to set parameters.

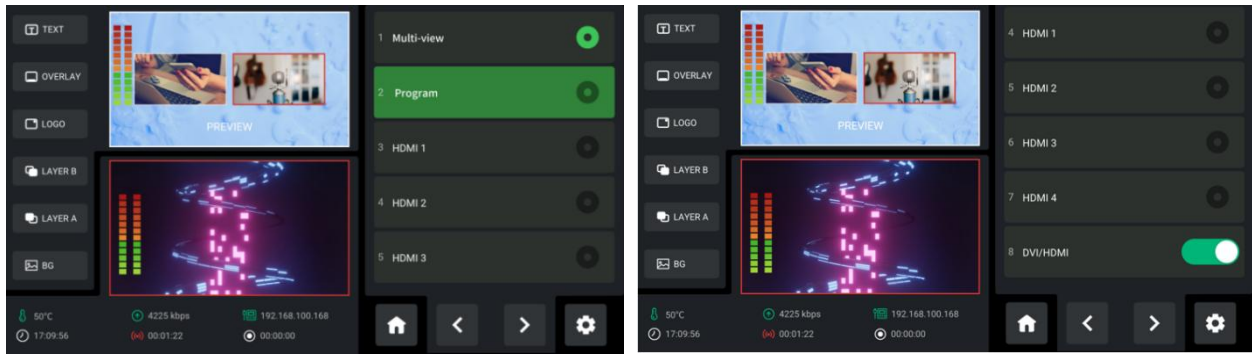

Default to be Multi-view preview, which can be switched to Program, Test Pattern or 1~4 HDMI inputs for various applications.

DVI/HDMI is turned on by default for connecting multiple display devices simultaneously. For example, DVI is generally used to adapt LED control cards (sending cards) and displays with DVI input interfaces, while HDMI is generally used to adapt displays with HDMI input interfaces.

Turn on DVI/HDMI, mini-mx can adapt to different types of display devices.

Users can return to Editing Interface to check input source preview on the touch screen.

3.9.2 Program

Click **Program** to set parameters.

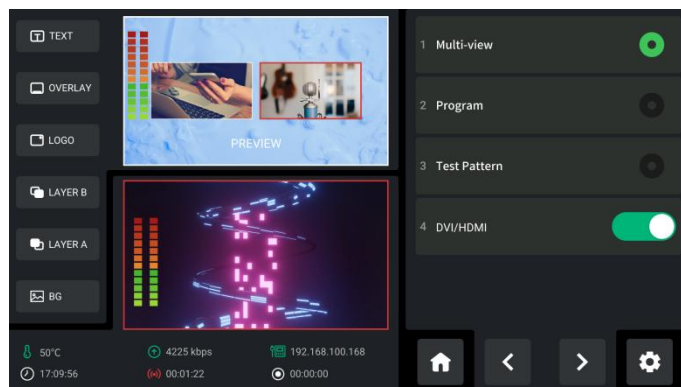

Default to be Program, which can be changed to multi-view Preview or Test Pattern.

3.9.3 Resolution

Click **Format** to choose output resolution.

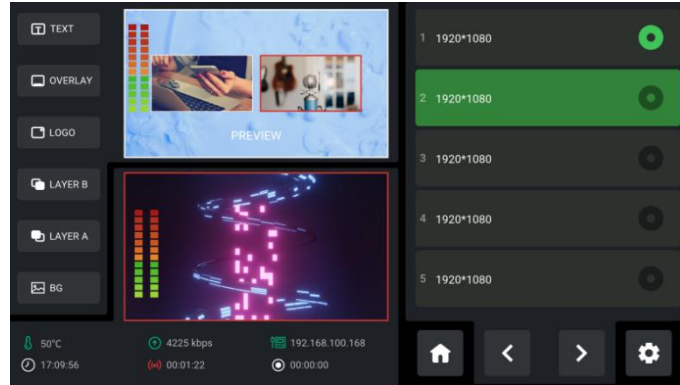

3.9.4 USB2 Mode

Click **USB2 Mode** to set the function of USB-C interface labeled number 2.

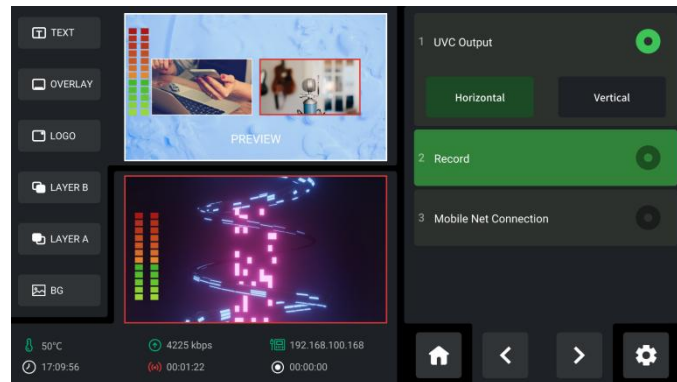

- UVC Output: USB port can be recognized as USB webcam to connect computer or mobile phone for streaming or video conference.
- Record: Insert U disk for [recording](#).
- Mobile Net Connection: Use with standard data cable to share network with mobile phone.

(Refer to [Smartphone Tethering](#)).



Note:

1. Make sure USB2 and USB1 interface are in different functions when setting USB2 mode.
2. To ensure a successful mode switch, please disconnect USB2 interface first.

3.9.5 TAO Cloud Device Access

With TAO Cloud integrated directly into RGBlink device, such as mini-mx, you can do more

content production.

You can follow steps below to bind mini-mx to TAO Cloud.

Click **TAO Cloud** to enter the following interface.



Follow the steps in the box to get verification code.

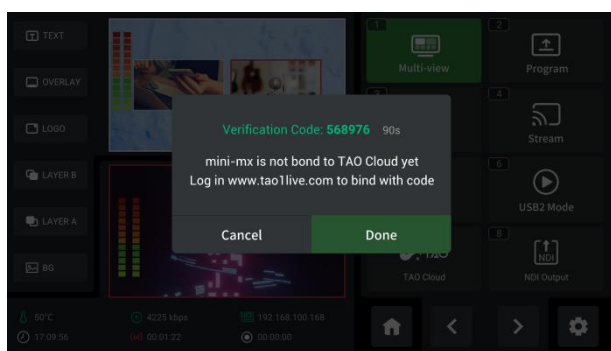

Enter TAO Cloud homepage. Click "All Appliances" > "Binding Devices" to enter interface as shown.

Enter device name (customizable) and verification code, then click "Bind" to confirm.

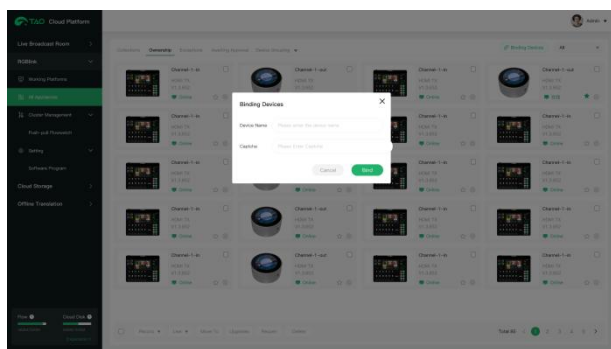

You can check binding status in All Appliances interface.

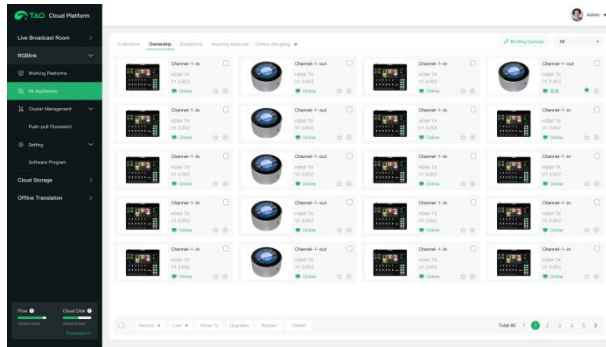

If you want to unbind, use the ENTER Button to select "TAO Cloud" once again and then select "Rebind".

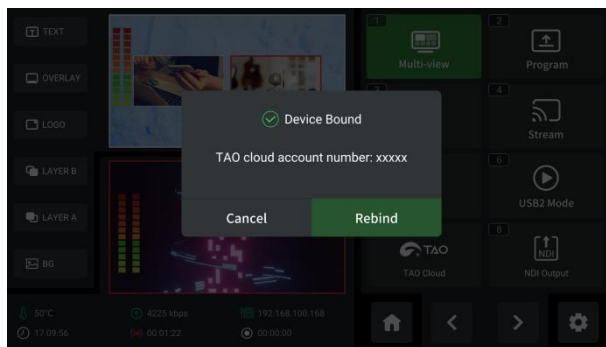

Then you can choose to rebind or perform other operations.

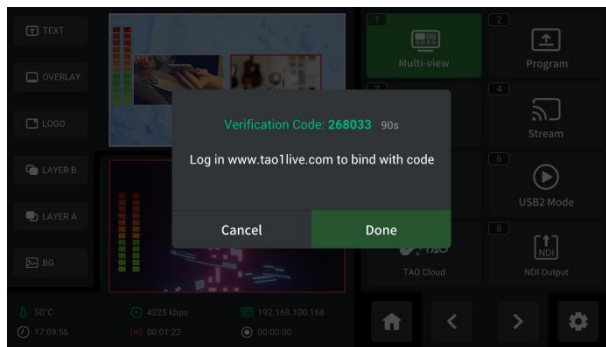

Note: If mini-mx has been connected to the internet, you can perform device unbinding via a factory reset.

3.10 Streaming

Push MENU Button to enter MENU.

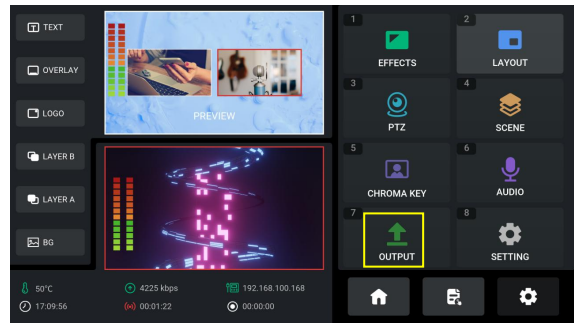

Tap **Stream** in **【OUTPUT】** menu to enter streaming configuration interface.

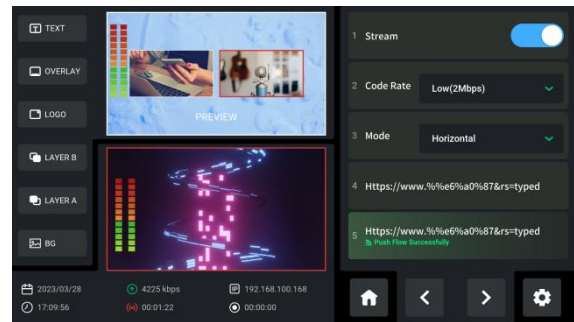
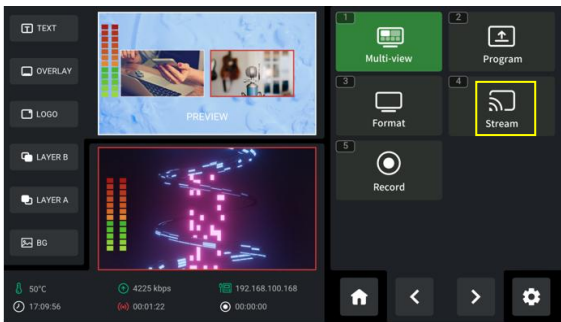

Please check network communication before enabling streaming.

You can provide network for mini-mx through **Direct Connection** or **Smartphone Tethering**.

3.10.1 Direct Connection

mini-mx switcher' s Ethernet connector lets you stream directly. Connect mini-mx to the internet by plugging a network cable from the Ethernet port to an internet router or a network switch. It is recommended to use RGBlink CAT6 cable with order code as 940-0001-00-11-0.

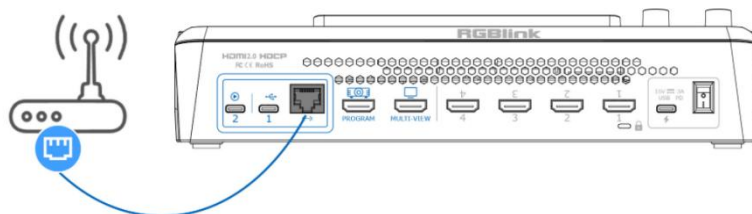

3.10.2 Smartphone Tethering

1. For iOS system, please do as follows:

1) Simply connect a standard power cord from your smartphone to the USB-C port labeled number 1 on your mini-mx.

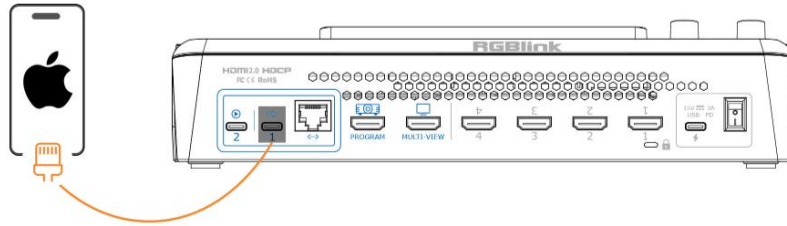

2) Then the 'Trust This Computer' alert message will appear on your device. Tap 'Trust' on your device and do as followings: Open 'Settings' > Select 'Personal Hotspot' > Enter 'WLAN Password' > Turn on 'Allow Others to Join' .

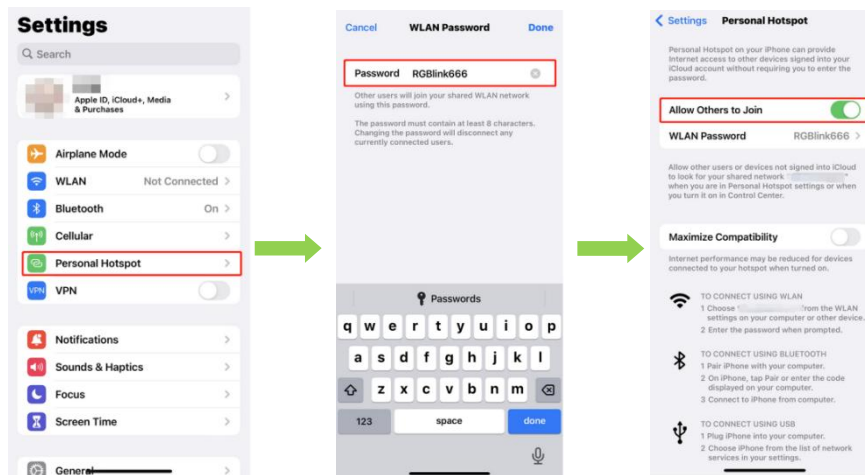

3) Tap SETTING in MENU or Button 8 to enter following interface. You can also access to Setting Interface by clicking  icon. Tap Network in Setting and then select **Mobile** to stream by using the hotspot of mobile phone.

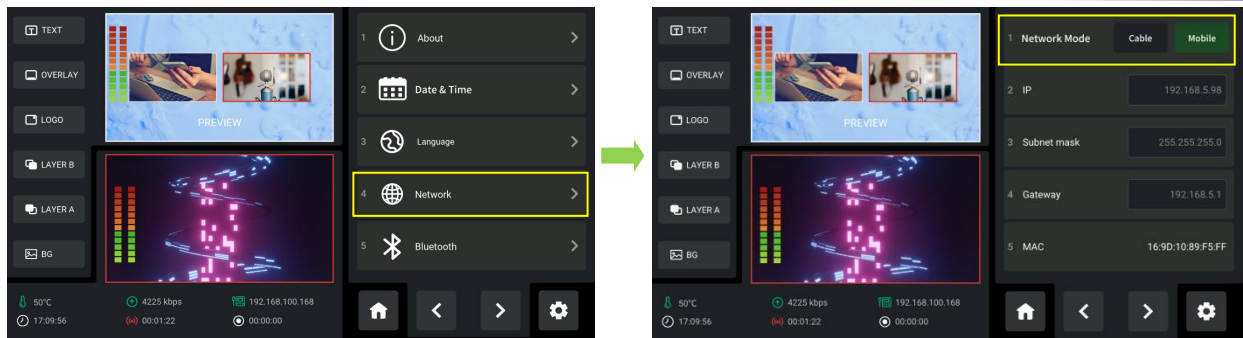

4) As shown in figures below, if the status changes from "Not Discoverable" to "Connection", it means that the mini-mx and your mobile phone have achieved network sharing.

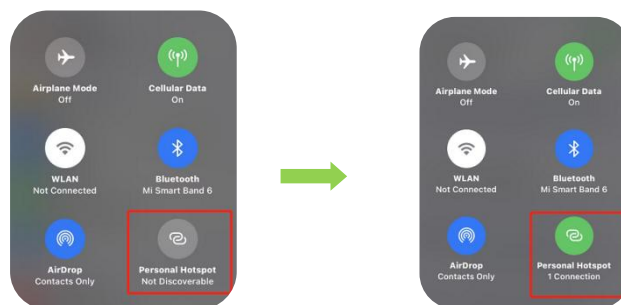

2. For Android system, please do as follows:

1) Open 'Settings' > 'Additional settings' > 'Developer options' > Turn on 'USB debugging' .

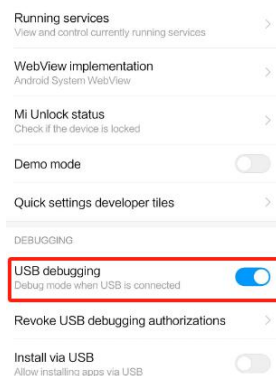

2) Simply connect a standard power cord from your smartphone to the USB-C port labeled number 1 on your mini-mx.

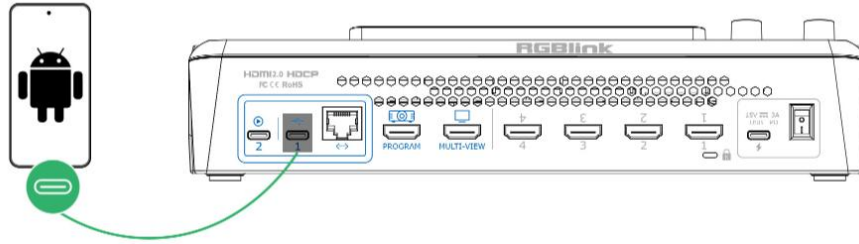

3) Open 'Settings' > Select 'Mobile Network' > 'Personal Hotspot' > 'Other Sharing Mode' > Turn on 'Share Phone Network via USB' .

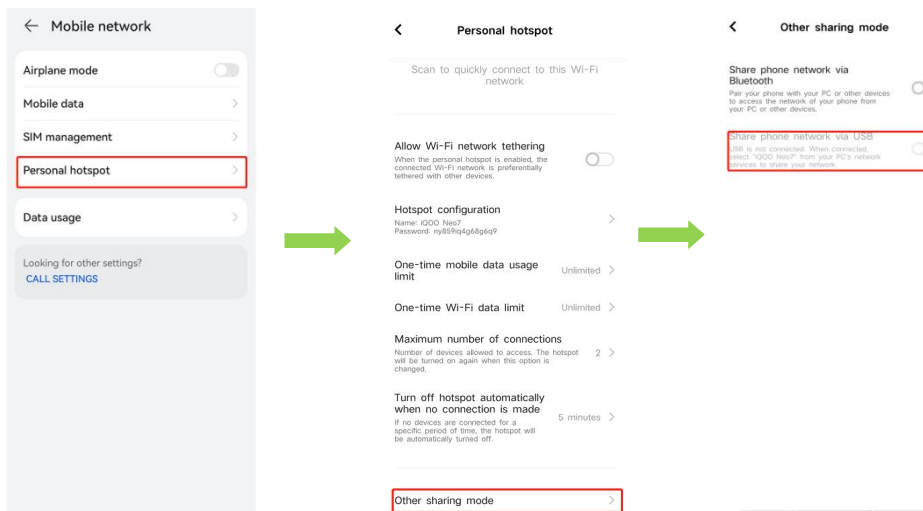

4) Tap SETTING in MENU or Button 8 to enter following interface. You can also access to Setting Interface by clicking  icon. Tap Network in Setting and then select **Mobile** to stream by using the hotspot of mobile phone.

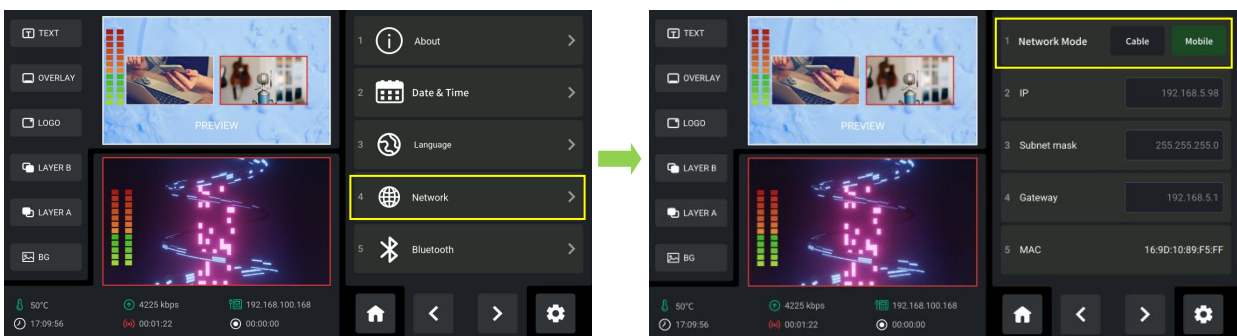

Warning:

1. Select **Cable** when using local network for streaming.
2. If failed to use network sharing, please operate Step 2 as follows: Connect USB-C interface of OTG cable to mini-mx, then use standard data cable to connect your phone to USB-A interface of OTG cable.
3. The user interface may vary according to mobile phone types, please refer to the actual use.

3.10.3 YouTube Live

In above operations, mini-mx has been connected to network. Then prepare a USB disk to import streaming address and do as the steps below. This chapter takes YouTube Live as the example.

1. Log into your YouTube account on your computer;
2. Click the camera icon in the top right corner to create a video.

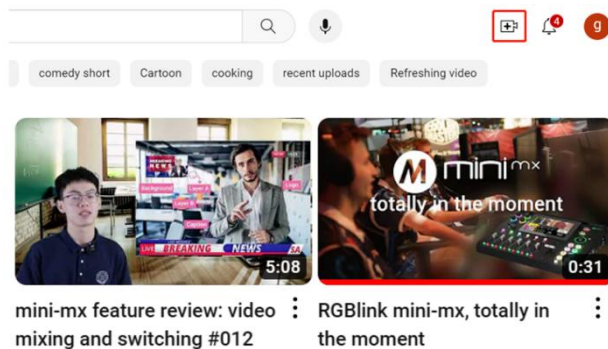

3. Select "go live" .

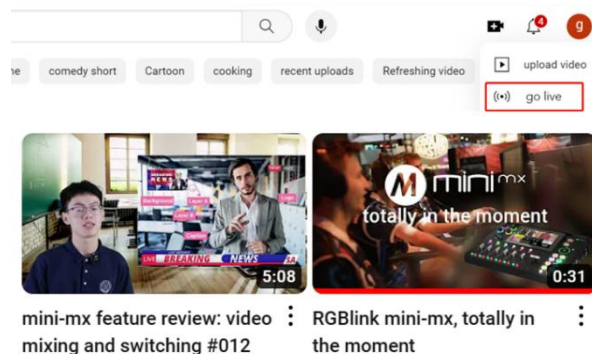

4. Type in a title and add a description in the dialogue box, click "create stream" and then copy the Stream URL and Stream Key.

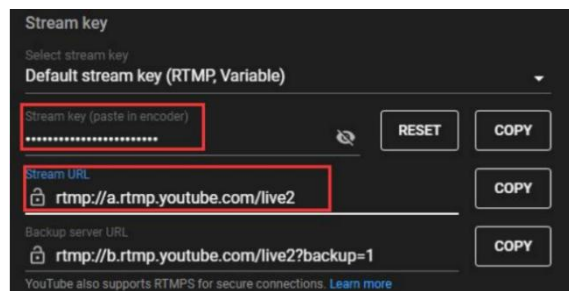

5. Press "Windows" key and "R" key to open "Run" dialog box. Type "notepad" and click the "OK" .

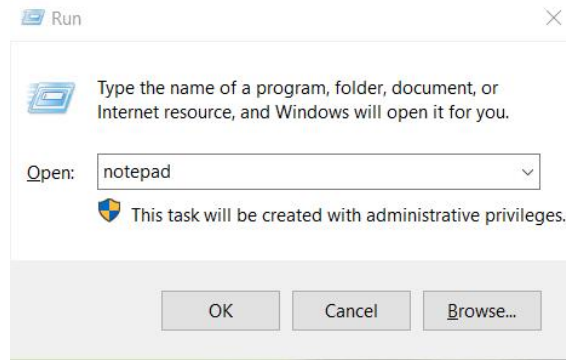

6. Paste the Stream URL and Stream Key in notepad and save file title as **rtmp.ini** (the format must be : **rtmp://YOUR STREAM URL/YOUR STREAM KEY**). Then copy the file to USB disk.

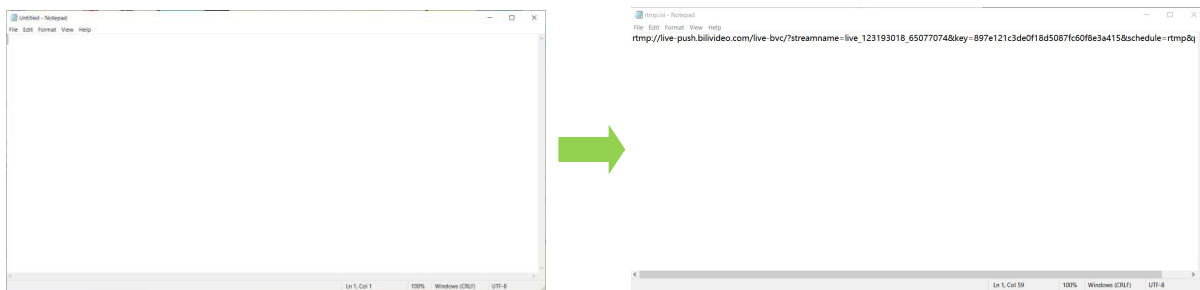

7. Connect the USB disk to mini-mx' s USB port.

As shown in the figure below, users can view the imported streaming address and streaming status. All addresses are in gray by default, which indicates **un-selected state**. Click to select required stream address. Address in green filling bank indicates **selected status**.

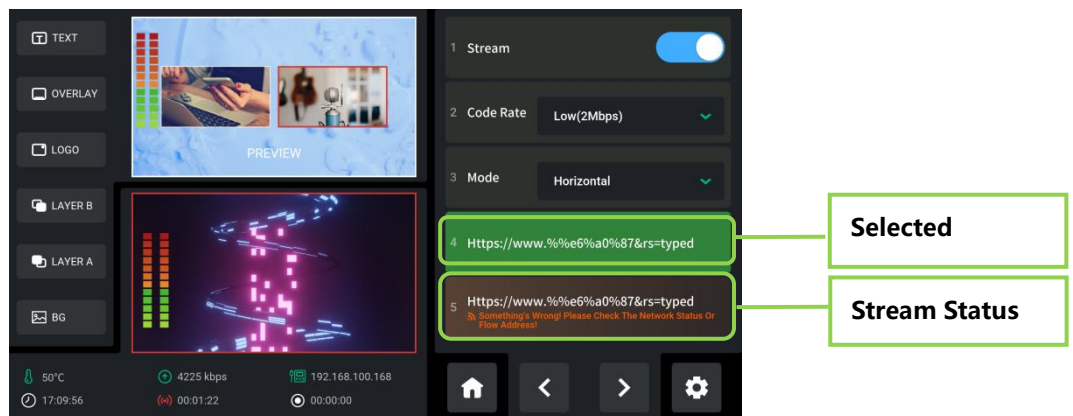

mini-mx supports streaming up to 2 platforms at the same time. Turn on Stream on the interface or push ON AIR Button on the front panel to start streaming.

Users can according to the actual situation to adjust the Code Rate and Mode of the live video as

needed. For example, if the network speed is slow, the Code Rate can be switched to a lower level.

3.10.4 Controlling PTZ Camera During Live

To control PTZ camera while performing live streaming, please make sure PTZ, mini-mx and network are in the same LAN, then turn on DHCP of mini-mx in Network Interface at the same time. (Turning off DHCP will not affect live streaming if the IP address does not conflict)

Click **Network** on Setting Menu to configure IP address.

IP Setting:

Dynamic (IP configured by router) : Connecting mini-mx with a router with DHCP features. Turn on DHCP of mini-mx and the router, then mini-mx will capture an IP address automatically.

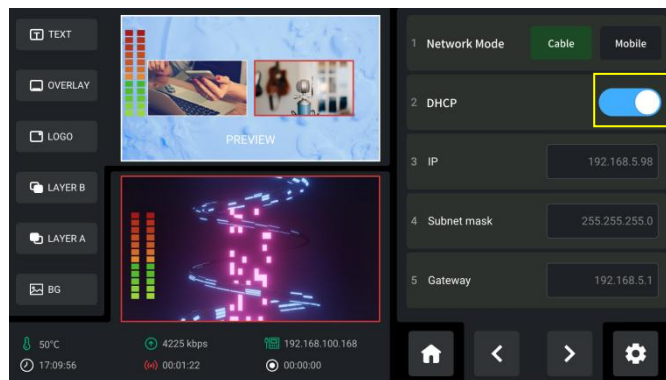

Static (set IP freely by yourself): Turn off DHCP to manually set IP address. Then click “Enter” to conform your setting.

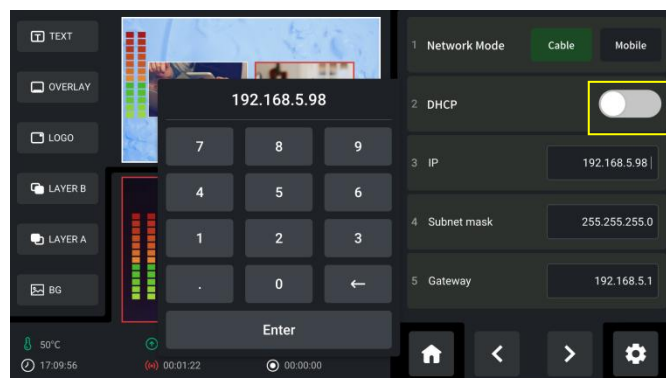

Subnet mask: Set the subnet mask. The default setting is 255.255.255.0.

Gateway: Set the Gateway according to the IP address and subnet mask. For example, if the IP address of mini-mx is 192.168.5.98 and the subnet mask is 255.255.255.0, please set the gateway to 192.168.5.1.

 **Note:** Please refer to [Controlling PTZ Camera](#) for PTZ operations.

3.11 Recording

The mini-mx **supports recording streaming media content** to an external USB storage through the USB 3.0 interface.

The supported format is exFAT. The recorded video will be sectioned after storage up to 4G with each section.



Insert a U disk to USB port labeled number 1. Before recording, format the U-disk first.

You can directly format U-disk on your mini-mx. The steps are as below:

Push MENU Button to enter Menu

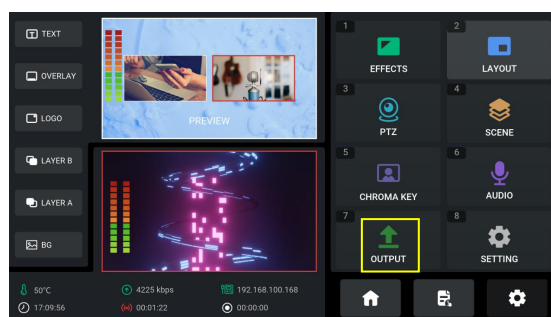

Tap **【OUTPUT】** in MENU or push Button 7 to enter Video Output interface, then choose **Record** to enter recording configuration interface. If no USB disk is inserted, the interface displays as follows:

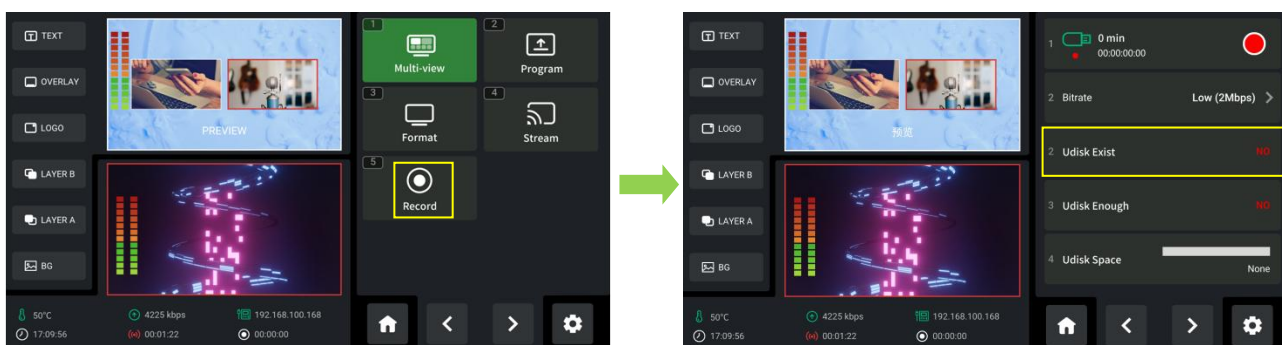

After USB disk is inserted, please do as follows: Set the file system to exFAT and the size of allocation unit to 128kb > click Disk formatting > tap Confirm to format disk.

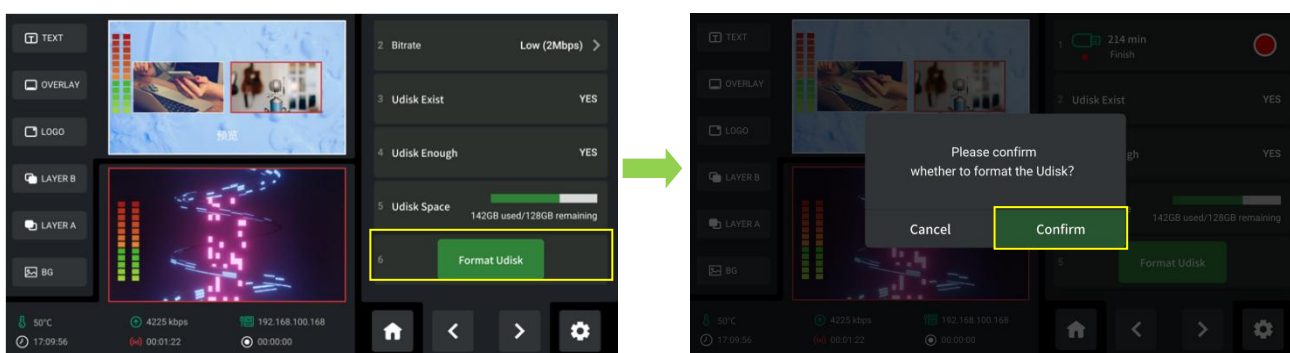

Warning:

If the U disk cannot be recognized when inserting into mini-mx, use a dual USB cable to power U disk.

In Recording interface, the disk information can be captured automatically by mini-mx.

Tap Recording switch to start or stop recording, and you can check recording duration and progress.

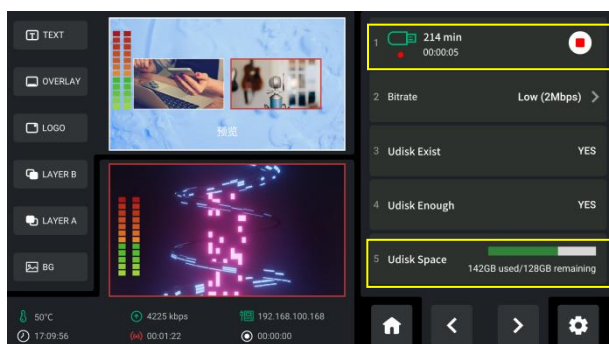

3.12 Switch Effect Setting

Push MENU Button to enter MENU.





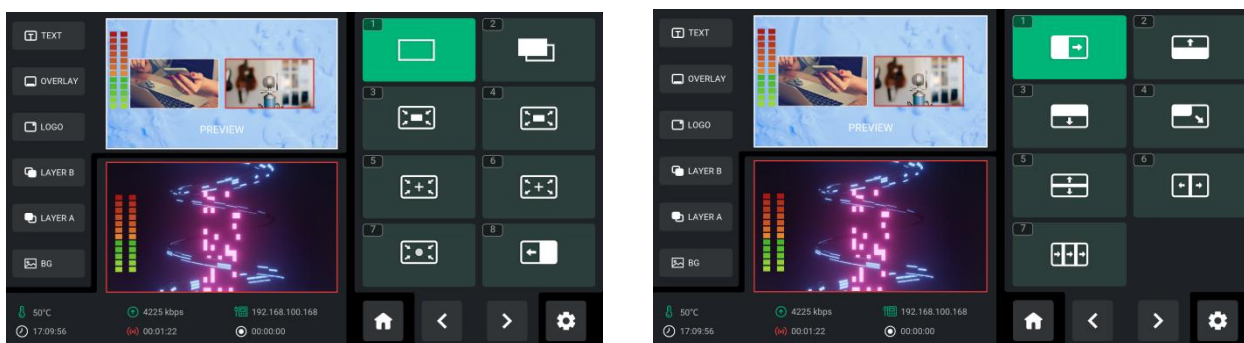





Tap **【EFFECTS】** or push Button 1 to enter the following interface. You can also access to EFFECT by long pressing PROGRAM Window. 15 transition effects in total can be selected. Use Button **【Page Up】** and **【Page Down】** to choose effect you need.



You can refer to the following table and illustration.

	Cut
	Fade
	Box Inwards
	Iris Box
	Cross Inwards
	Iris Cross

	Circle Inwards
	Wipe to Left
	Wipe to Right
	Wipe to Top
	Wipe to Bottom
	Wipe to Bottom Right
	Center Split Vertical
	Center Split
	Blinds Vertical

-  **CUT:** The Picture 1 switches to Picture 2 instantly with no transition effect.



-  **FADE:** FADE is a transition from Picture 1 to Picture 2 and two pictures are blended together during switching process.



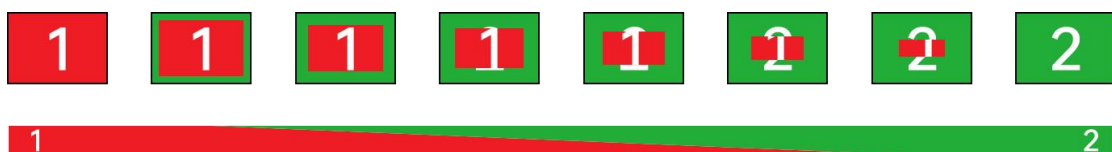

-  **Box Inwards:** Box Inwards refers to replacing Picture 1 by Picture 2 and is achieved by using a box pattern closing in from the edge towards center.

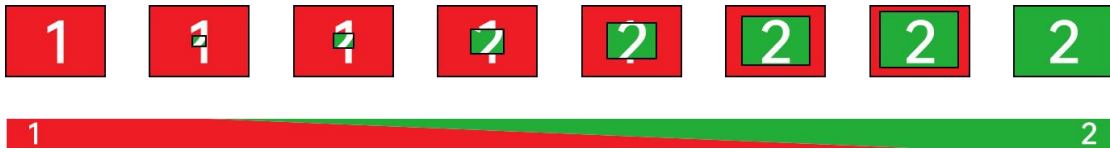

-  **Iris Box:** Iris Box refers to replacing Picture 1 by Picture 2 and is achieved by using a box pattern

growing from the center and progressing outward.



- 
Cross Inwards: Cross Inwards refers to replacing Picture 1 by Picture 2 and is achieved by using a cross pattern closing in from the edge towards center.

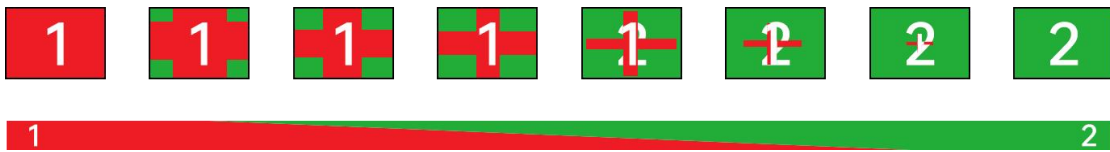

- 
Iris Cross: Iris Cross refers to replacing Picture 1 by Picture 2 and is achieved by using a cross pattern growing from the center and progressing outward.

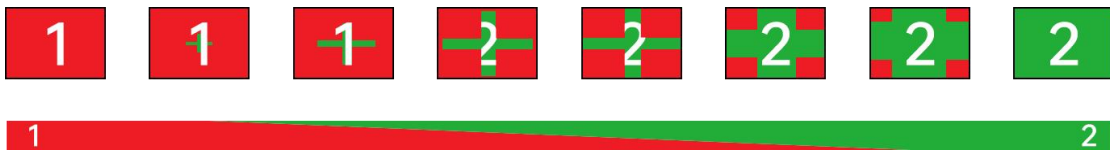

- 
Circle Inwards: Circle Inwards refers to replacing Picture 1 by Picture 2 and is achieved by using a circle pattern closing in from the edge towards center.

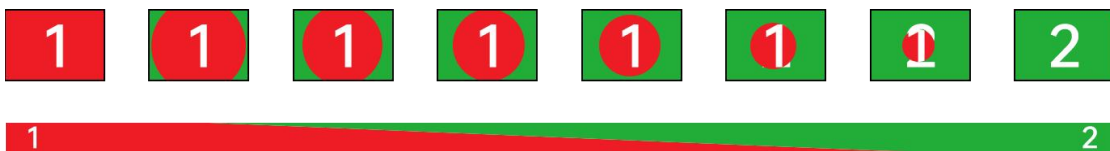

- 
Wipe to Left: The Picture 1 is unchanged, and the Picture 2 is gradually wiped in to replace Picture 1 from the leftward direction.

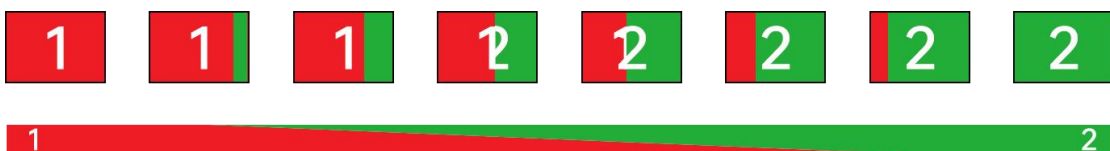

- 
Wipe to Right: The Picture 1 is unchanged, and the Picture 2 is gradually wiped in to replace Picture 1 from the rightward direction.

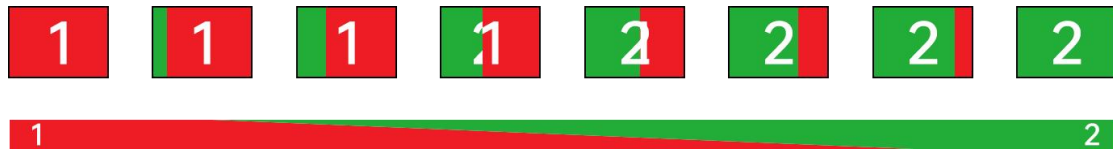

- 
Wipe to Top: The Picture 1 is unchanged, and the Picture 2 is gradually wiped in to replace Picture 1 from the upward direction.

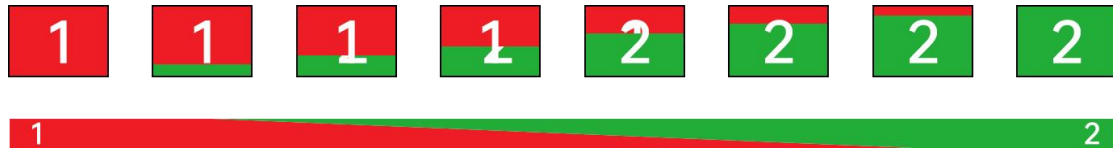

- 
Wipe to Bottom: The Picture 1 is unchanged, and the Picture 2 is gradually wiped in to replace Picture 1 from the downward direction.

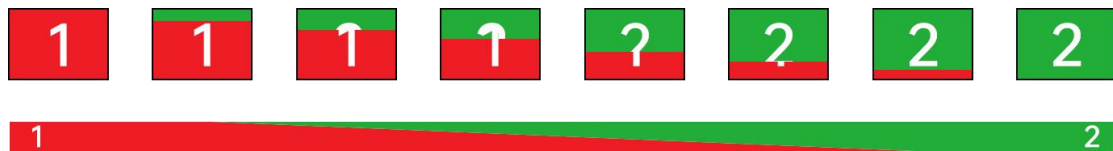

- 
Wipe to Bottom Right: The Picture 1 is unchanged, and the Picture 2 is gradually wiped in to replace Picture 1 from the diagonal direction.

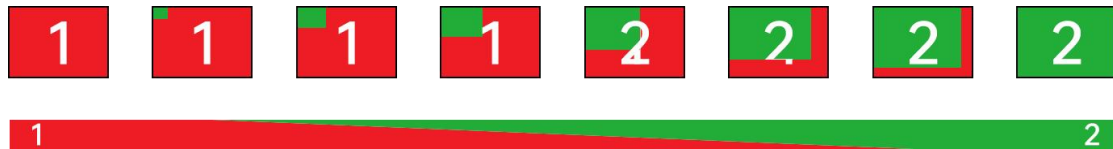

- 
Center Split Vertical: The Picture 1 is unchanged, and the Picture 2 grows from the center and extends vertically.

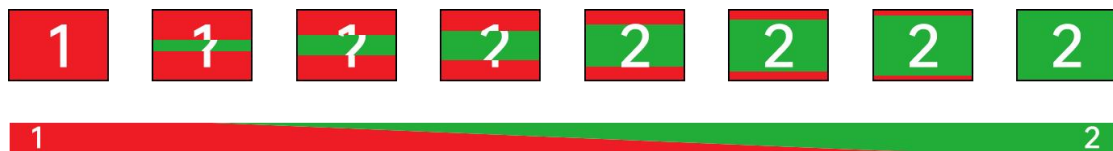

- 
Center Split Horizontal: The Picture 1 is unchanged, and the Picture 2 grows from the center and extends horizontally.

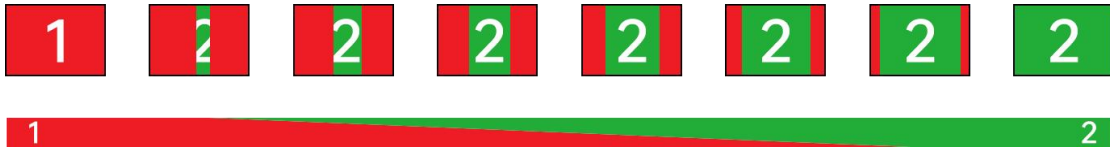

- Blinds Vertical:** Blinds Vertical refers to an animation that imitates opening or closing blinds from a vertical direction. The Picture 1 is unchanged, and the Picture 2 which is divided into bars extend vertically.

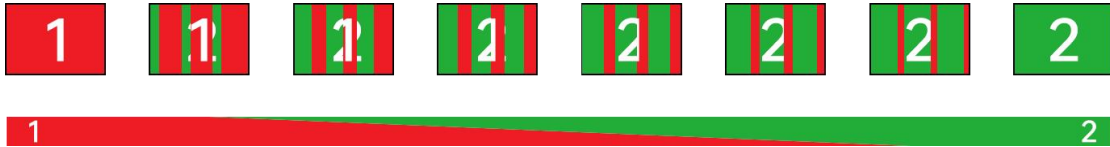

3.13 Audio

mini-mx supports mixed output of multiple channels, and also allows user to check volume meter.

You can refer to Audio Block Diagram below for application.

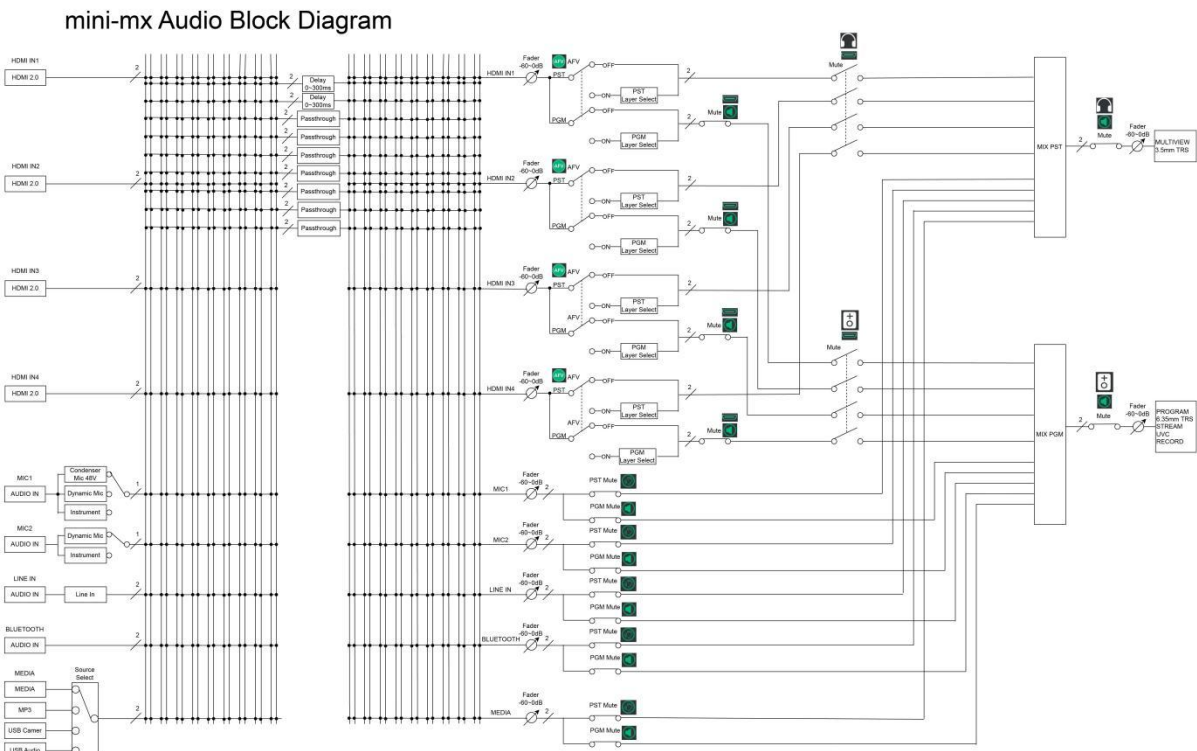

Push MENU Button to enter MENU.

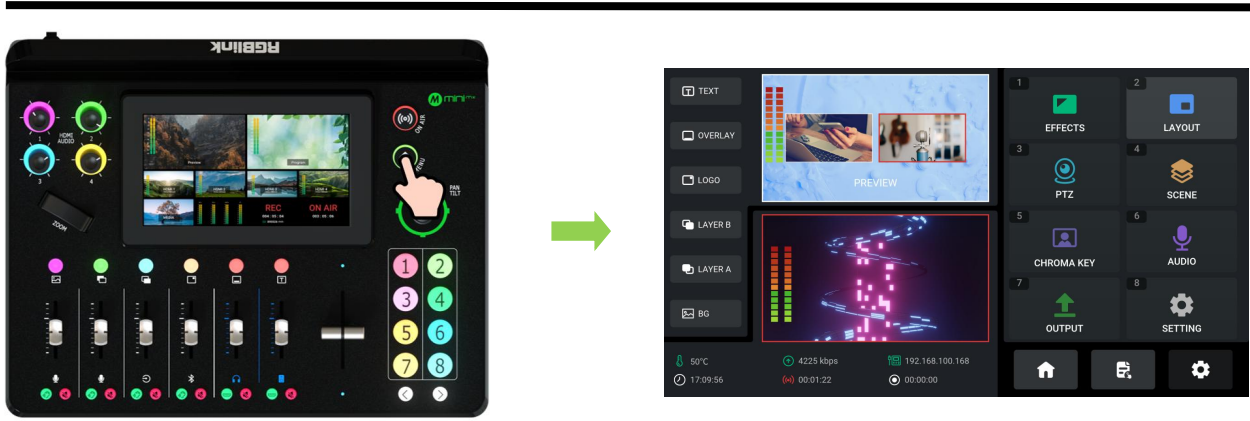

Tap **【AUDIO】** or push Button 6 to enter the Audio Management Interface. You can also access to the following interface by single click/double click/long press on Audio Monitoring Area on Main Interface.

As shown in the figure below, the Audio Management Interface is divided into eight parts. Please refer to the following table for operation.

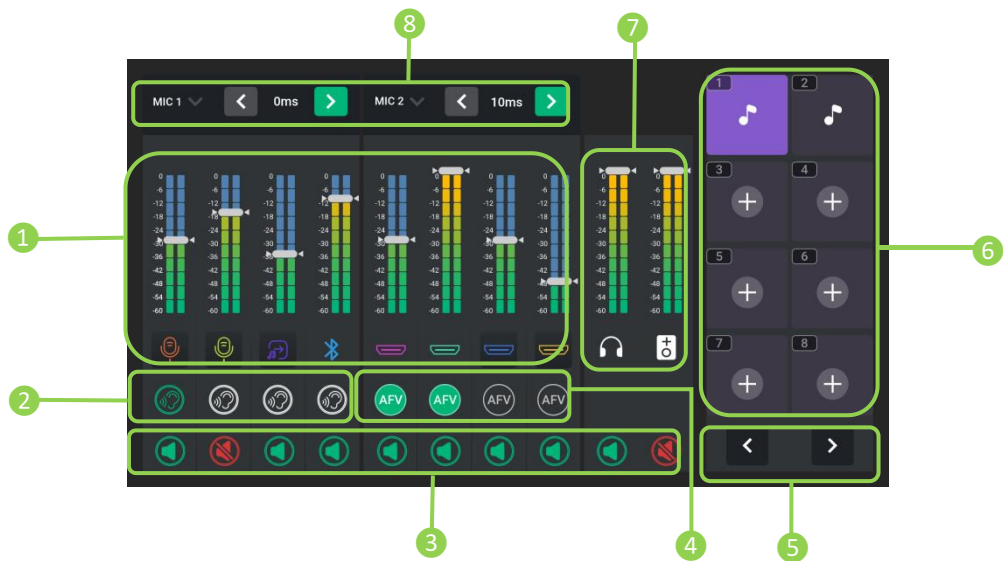

<p>① Input Audio Meters</p>	<ul style="list-style-type: none"> • Indicate MIC 1、 MIC 2、 Line-in、 Bluetooth、 HDMI 1、 HDMI 2、 HDMI 3、 HDMI 4. • Icon below virtual slider will display different colors: <ul style="list-style-type: none"> - Icon in gray indicates no input for Bluetooth、 HDMI 1、 HDMI 2、 HDMI 3 or HDMI 4. - Icon in corresponding color indicates there is an active input signal. • Use channel fader or white virtual slider to adjust volume. • 1~4 HDMI inputs support embedded audio adjustment via control knob on front panel. • MIC 1、 MIC 2、 Line-in、 Bluetooth support audio adjustment via channel fader on front panel.
<p>② Analog Input Monitoring Switch</p>	<ul style="list-style-type: none"> • Default to OFF. • Press to turn on with icon illuminated green.
<p>③ Mute Buttons</p>	<ul style="list-style-type: none"> • Press to turn on/off: Icon illuminated green indicates OFF and red indicates ON. • Mute analog input, the channel is muted only on Program out. • Mute HDMI input, the HDMI channel is muted on Program out; users can also monitor audio if there is HDMI input in the Preview out. • Mute PVW out, audio cannot be captured in Preview out. • Mute PGM out, audio cannot be captured in Program out.
<p>④ AFV</p>	<ul style="list-style-type: none"> • AFV stands for audio follows video. Enable AFV, the audio follows the video switch to perform a soft gradual transition when video is switched. Disable AFV, the audio will be remained on during and after video switching. • Set AFV for any HDMI embedded audio so the audio switches with the video source to PVW and PGM automatically.
<p>⑤ Page Up/Down</p>	<ul style="list-style-type: none"> • Tap Page Up or Page Down icon to enter different audio clip storage page. • Tap Page Down icon to enter Media for audio management; tap Page Up or Page Down icon to back to Audio.

<p>6 Audio Clips</p>	<ul style="list-style-type: none"> • Audio clip storage and playback area. • Tap to play audio in Program out. • Icon in green indicates playing status; icon in white indicates the audio clip has finished playing.
<p>7 Output Audio Meters</p>	<p>Indicate Headphone output and Program output.</p>
<p>8 Audio Delay</p>	<ul style="list-style-type: none"> • Configure audio delay for HDMI or MIC to keep audio in sync with the video. • Range: 0~300ms, increase or reduce 10ms each time.

Selecting Microphone and Setting Level

If the sound is too quiet or too loud, you need to control audio level. Tap MIC 1, MIC 2, Line-in input icon to set audio levels for microphone in different types.

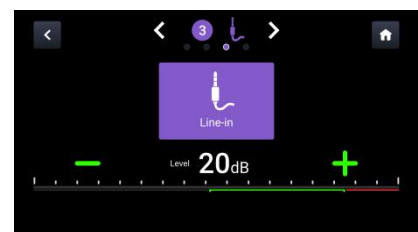
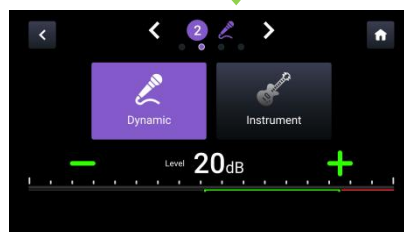
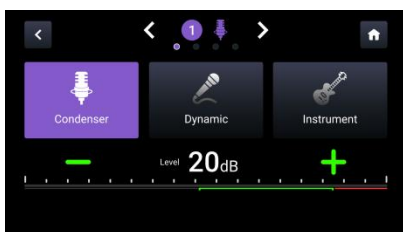
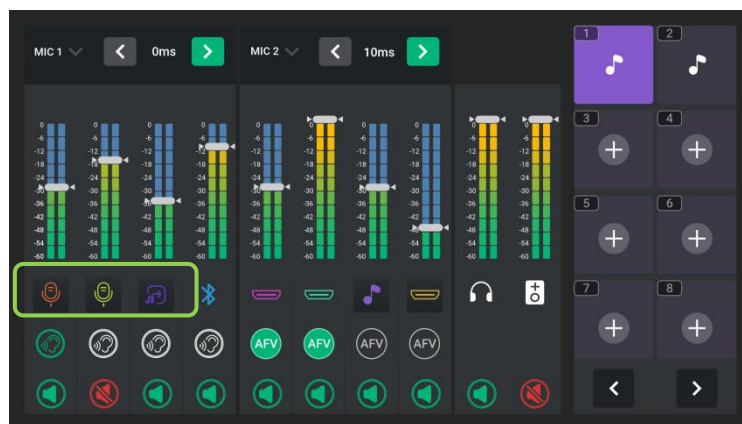

Tapping the "+" and "-" icons for each input will increase or decrease the audio level for the respective source.

3.14 Setting

Push MENU Button to enter MENU.

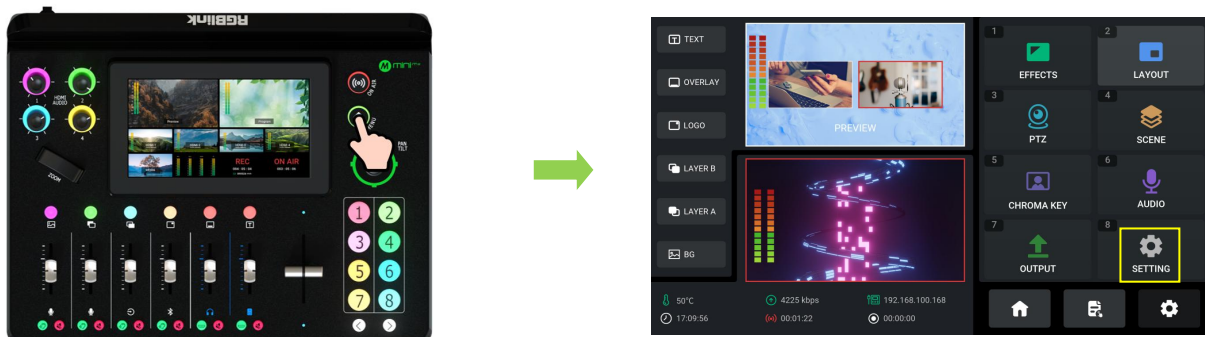

Tap **[SETTING]** or push Button 8 to enter Setting Interface. You can also access to Setting Interface by clicking  icon.



As shown in the figure above, functions including **About**, **Date&Time**, **Language**, **Network**, **Bluetooth**, **Views Auto Loop**, **VFA(Video Follow Audio)**, **Switch Mode**, **Reset**, **Auto-return**, **Fan**, **Display**, **T-Bar Correction** and **Color Management** are available.

3.14.1 About

Click **About** to check information about mini-mx. As shown in the figure below, users can view Device Name and SN serial number. Click Device Version to check current version and upgrade mini-mx. (More details please refer to [Upgrade](#))

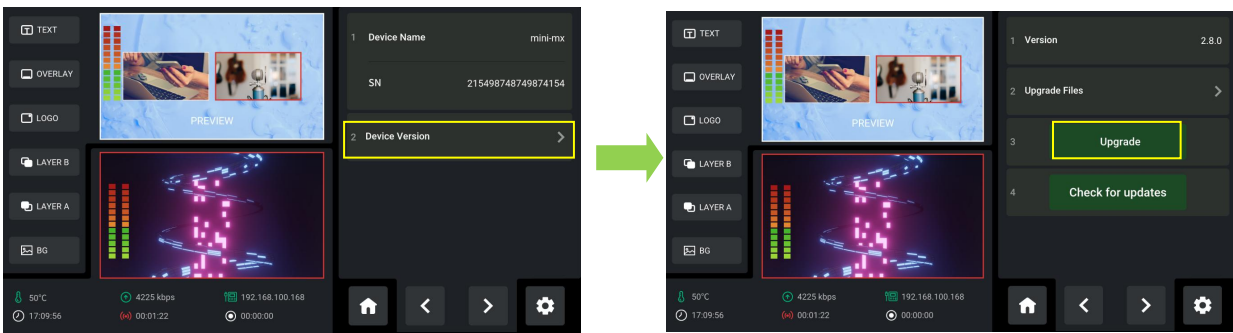

3.14.2 Date and Time

Click **Date & Time** to check operating time and set time displayed in mini-mx.

If the device is connected to network, turn on automatic setting switch to synchronize the time.

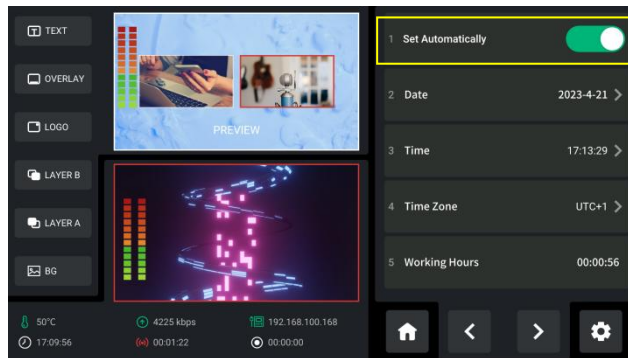

If the device is not connected to the network, users can set the time manually.

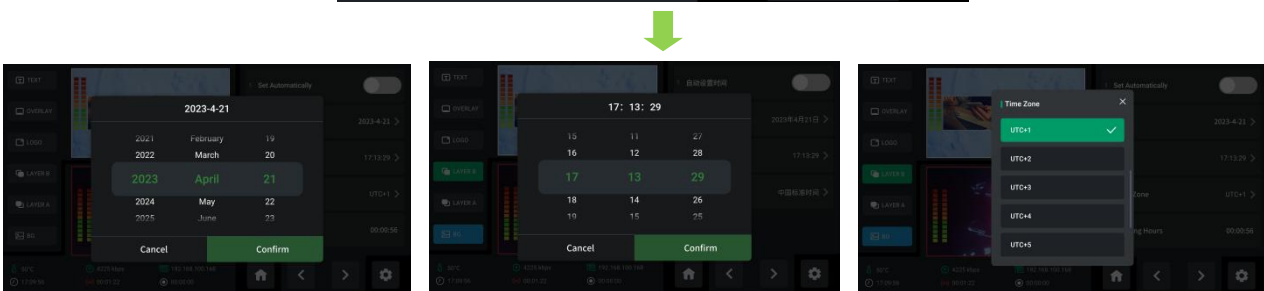
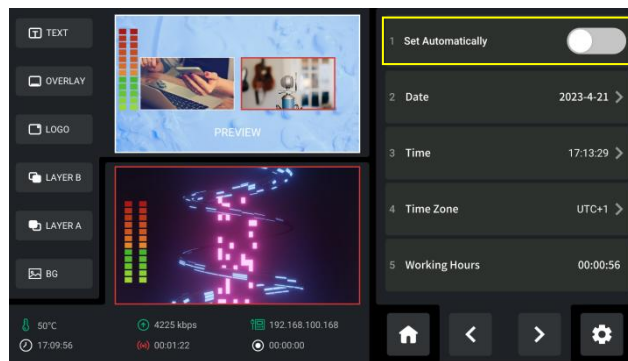

3.14.3 Language

Tap **Language** to enter the following interface.

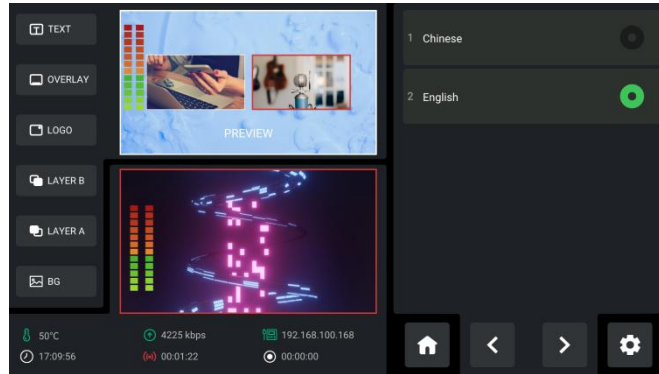

Set system language as English or Chinese.

3.14.4 Bluetooth

Tap **Bluetooth** to enter the following interface.

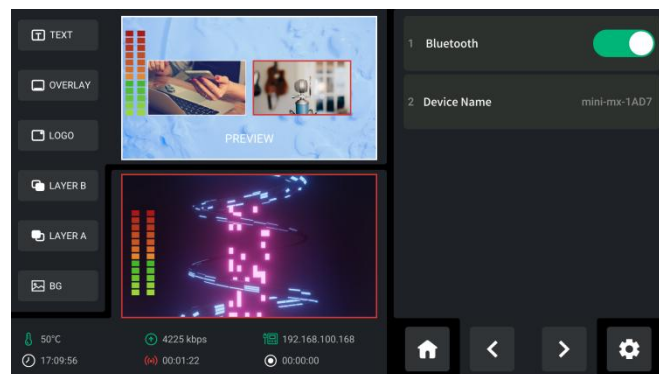

Bluetooth defaults to ON. Turn on Bluetooth on mini-mx and mobile phone to establish a Bluetooth connection. You can check device name in this interface and then select the mini-mx model that needs to be paired in the Bluetooth Setting Interface of the phone.

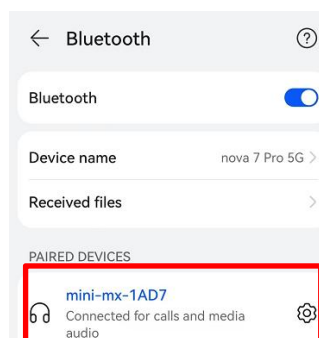

After successful connection of mini-mx and mobile phone, you can play music via Bluetooth.



Tips:

1. mini-mx is generally named as **mini-mx-XXXX**.
2. If there is no sound when playing music, please use the Channel Fader on the front panel to adjust the BLUETOOTH and PREVIEW volume to an appropriate level.

3.14.5 Views Auto Loop

Tap **Views Auto Loop** to enter the following interface.

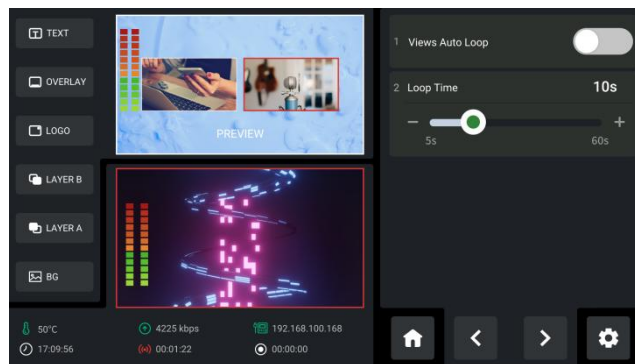

Views Auto Loop refers to the cyclic switching of saved views, allowing users to check multiple screens simultaneously. Enable the function to set the loop time between views. For example, if the loop time is set to 10 seconds, each view will be displayed for 10 seconds before automatically switching to the next view in a loop. After looping the last view, it will automatically jump to the first view and continue the loop.

3.14.6 VFA

VFA stands for **Video Follow Audio**, which refers to a feature where the video switches based on the audio level exceeding a preset threshold. This function can be achieved on mini-mx via loading presets.

Tap **VFA** to enter the following interface.

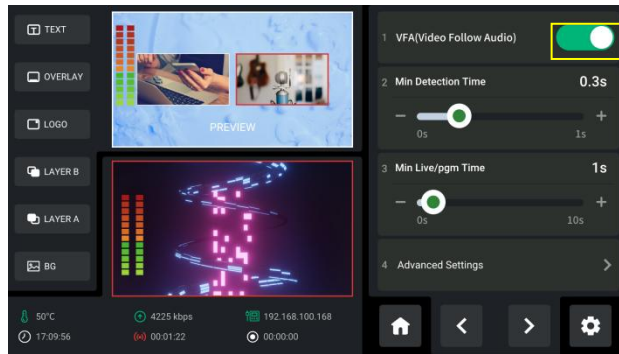

Switch on VFA(Video Follow Audio), then click Advanced Settings to set specific parameters. Users can enable switch, select a view, and set threshold value for each signal. The threshold can be set from -60 to 0, with a default of -20. The threshold refers to the sensitivity of the system to recognize a view switch. A smaller threshold makes view switch more sensitive.

Audio Source	Threshold(dB)	Action to Take	Switch
UNREACHED	/	VIEW 3	ON
MIC 1	-40	VIEW 1	ON
HDMI 2	-20	VIEW 2	ON
LINE	-20	VIEW 1	OFF
BT	-20	VIEW 1	OFF

As shown in figure above, now you have connected MIC1 interface to a microphone, and HDMI2 interface to a PC.

If there is audio input from MIC1, and the threshold reaches -40 or higher, the Program will automatically switch to VIEW 1. If there is embedded audio input from HDMI2 interface, and the threshold reaches -20 or higher, the Program will automatically switch to VIEW 2. If neither of the audio inputs from two channels reaches the respective threshold, that is, in the UNREACHED mode, the Program will automatically switch to VIEW 3.

Return to previous interface to adjust parameters according to needs. **Min Detection Time** refers to the time the system waits after receiving an audio level exceeding the set threshold before

switching views. If the Min Detection Time is set to 0s, the system will switch to the corresponding view immediately once the audio level exceeds the threshold. **Min Live/PGM Time** refers to the interval between the actual switch after the system receives a command and the last switch. By default, the Min Live/PGM time is set to 2 seconds.



Warning: It is suggested that the min Live/PGM time should be **not less than 2 seconds**.

3.14.7 Switch Mode

Click **Switch Mode** to select T-Bar PVW Mode or CUT Mode.

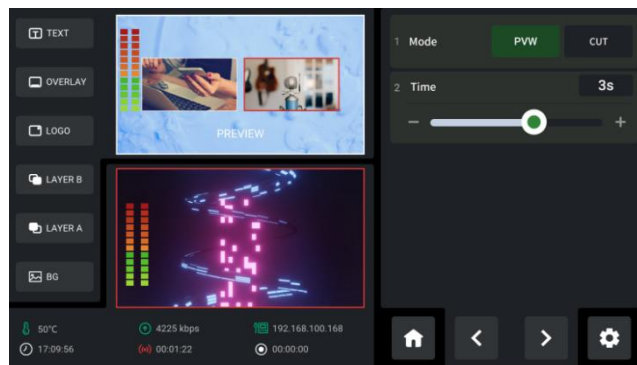

mini-mx **defaults to T-Bar Mode**. Users can also switch to CUT Mode and then use Button 1~4 on the operation board to switch 4 HDMI inputs. The Button 1~4 corresponds to 4 HDMI inputs.

For some important occasions, users might need to preview and preset the next scene to ensure the accuracy and stability of the screen. mini-mx provides T-Bar PVW mode to allow switch after editing and confirmation.

When PVW Mode is enabled, all operation could be checked on PVW window. Slide T-Bar to switch between PVW and PGM. Switch time can be customized by sliding the time bar.



Warning:

Only CUT mode supports time setting.

3.14.8 Reset

Tap **Reset** to check current version of mini-mx and perform factory reset.

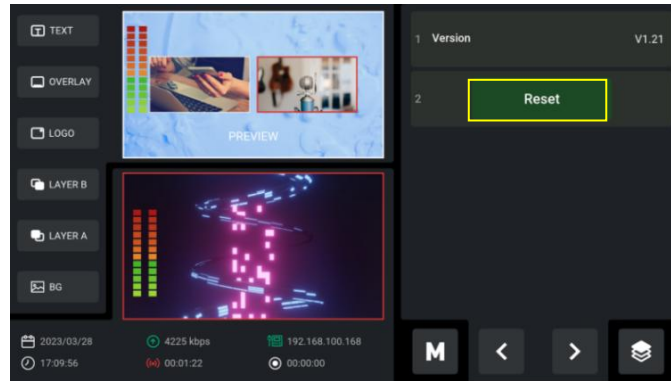

3.14.9 Auto Return

Click **Auto Return** to enter following interface. Use slider to disable Auto PVW or set interval to 15s, 30s, 45s or 60s.

As shown in the figure below, if interval is set to 15s, the screen will automatically return to the Main Interface.

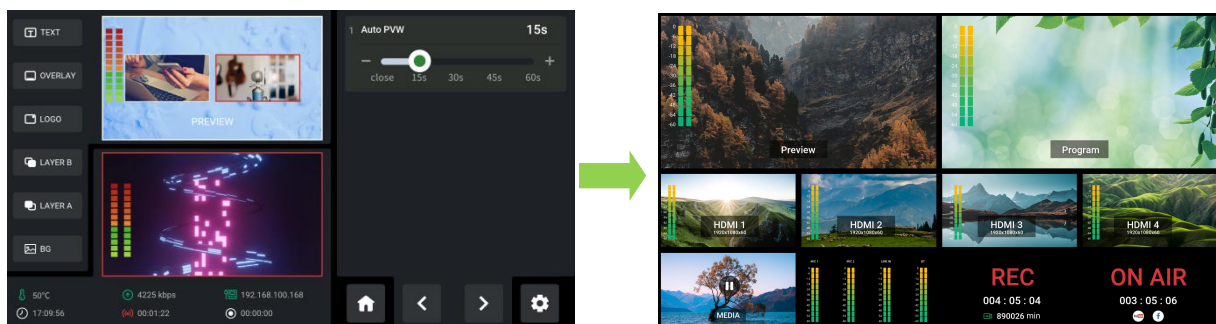

3.14.10 Fan

Tap **Fan** for fan speed adjustment.

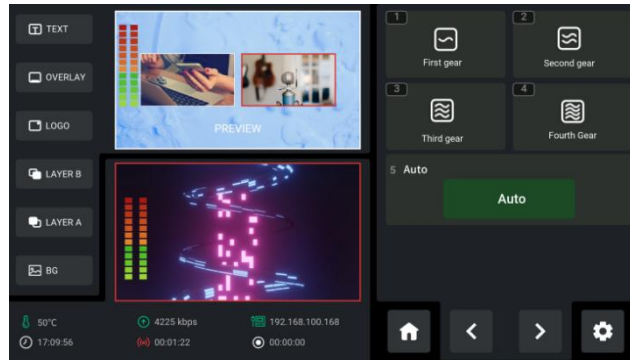

In the fan control interface, four levels of fan speed for users to choose from. Tap **Auto** to achieve automatic adjustment of the fan speed.

3.14.11 Display

Tap **Display** and use slider bar or adjuster to control brightness of touch screen and buttons.

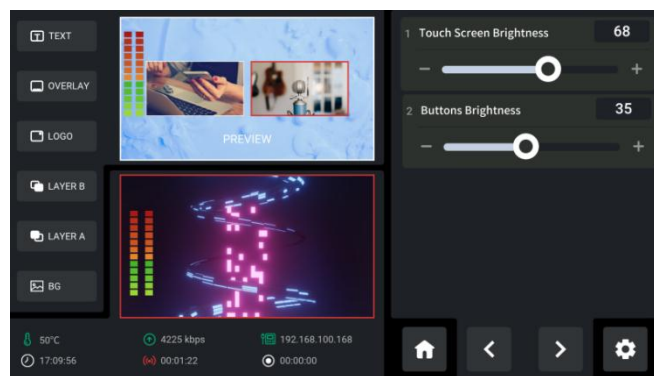

3.14.12 T-Bar Correction

Tap **T-Bar Correction** to enter the interface below.

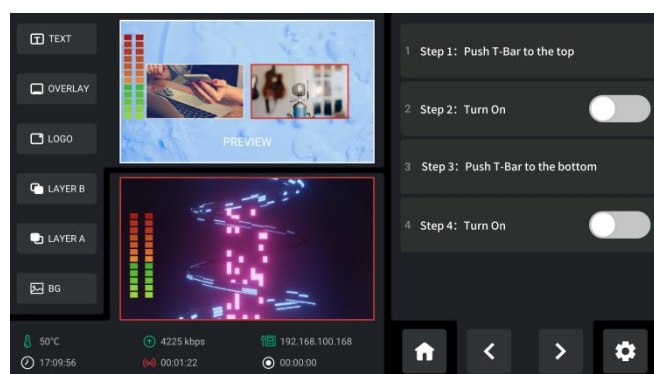

To ensure accuracy during use, T-Bar calibration is necessary before using.

- 1) Push the T-bar to the most top;
- 2) Enable switch on Step 2;

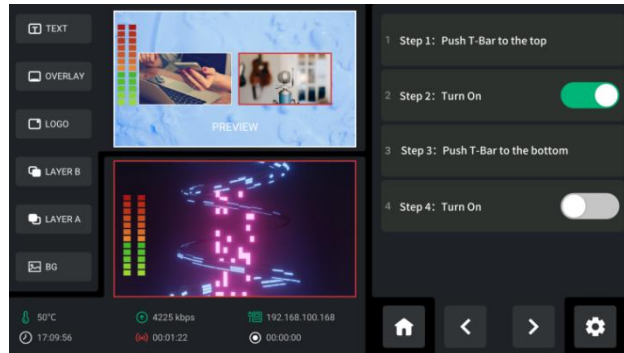

- 3) Push the T-bar to the most bottom;
- 4) Enable switch on Step 4;

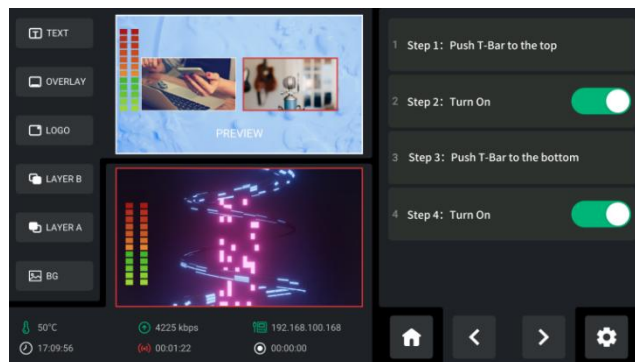

3.14.13 Color Management

Tap **Color Management** to enter the interface below.

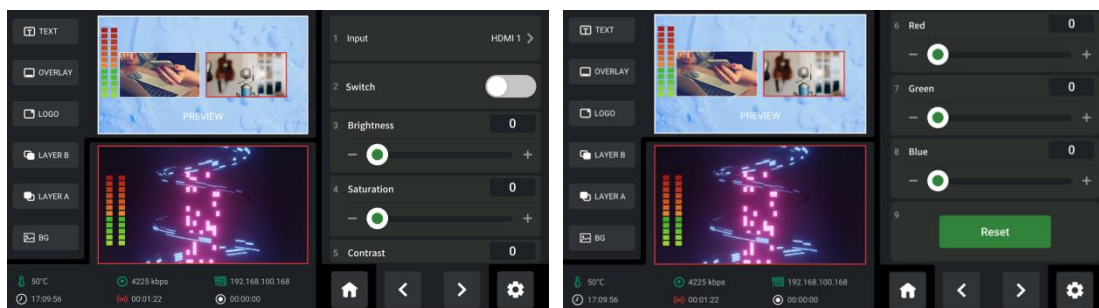

Enable switch to set brightness, saturation, contrast, red, green and blue values for four HDMI inputs.

Chapter 4 Ordering Codes

4.1 Product Code

230-0004-01-0

mini-mx

Chapter 5 Appendix

5.1 Specification

Connectors	Input	HDMI 4K	4×HDMI-A	
	Output	HDMI 2K	1×HDMI-A	
		USB (Stream)	1×USB-C	
		USB (Record)	1×USB-C	
	Audio	In	2×6.35mm XLR + TS Jack 1×6.35mm TRS Jack	
		Out	1×6.35mm TRS Jack 1×3.5mm mini-Jack	
	Communication	LAN	1×RJ45	
Power		1×USB-C		
Performance	Input Resolutions	HDMI	1280×720@50/59.94/60 1024×768@60 1280×768@60 1280×800@60 1280×1024@60 1360×768@60 1366×768@60 1440×900@60 1600×1200@60 1680×1050@60 1920×1200@60 1920×1080i@50/59.94/60 1920×1080p@23.98/24/25/29.97/30/50/59.94/60 3840×2160p@30/50/60 4096×2160@30/50/60	
	Output Resolutions	HDMI/ USB(webcam)	1280×720@50/60 1920×1080@24/25/30/50/60	
	Video	Video Formats	HDMI 2.0 HDCP 2.2	
		Color Space	RGB 8bit	
		Video Sampling	4:4:4 YUV	
		Video Latency	<4 frames	
	Audio	Line In Delay	up to 8 frames	
		Audio Format	HDMI	Linear PCM, 24 bits/48 kHz, 2 ch
			USB	Linear PCM, 16 bits/48 kHz, 2 ch
	Record/Storage	Record Formats	MP4 WAV	
	Disk Formats	FAT32(≤32 GB) exFAT(64GB~2T)		
Supported Standards	HDMI	2.0		
	USB	3.0		
	H.265	ITU-T H.265/ ISO/IEC 23008-2		

Power	Compatibility	USB Power Delivery (PD) 3.0		
	Supported Cables	Certified USB PD Aware		
	Input Voltage	Type-C 12V/3A		
	Maximum Power	36W		
Working Environment	Temperature	0°C~45°C		
	Humidity	10%~85% RH		
Physical	Weight	Net	1.48kg	
		Packaged	2.80kg	
	Dimension	Net	280.0mm × 222.6mm × 63.5mm	
		Packaged	332.0mm × 238.5mm × 109.0mm	

5.2 FAQ

1. Fail to power on mini-mx?

A: The Power Supply included with mini-mx is the recommended power supply to use. If you use other power supply, make sure the power supports 12V 3A. Then check whether the power supply is connected first, and use it correctly according to the power supply standard of your country/region. If still failed to power on mini-mx, please check whether the power cord is damaged. Please contact us if the device is damaged during transportation..

2. If there is a power supply problem with the mini-mx.

A: Please try to change the power adapter (support 36W).

3. mini-mx upgrade notes.

A: Please connect U disk with standard OTG cable for upgrade. If the upgrade file cannot be recognized, please check whether its in .img format; If the file still cannot be recognized, please replace the OTG cable or contact us..

4. mini-mx cannot control PTZ.

A: Please make sure that the IP address of mini-mx and PTZ are in the same network segment. For

example, the IP address of PTZ is 192.168.5.163. Please also set the IP address of mini-mx to 192.168.5.X ((2~254) except 163 Outside), confirm on mini XPOSE whether the Visca port number in the PTZ settings is the corresponding port number, for example, the Visca port number of the PTZ of RGBlink is 1259.

5. mini-mx USB 3.0 RECORD cannot recognize U disk.

A: Please format the U disk (exFAT).

6. mini-mx USB 3.0 WEBCAM cannot be recognized/recognized without picture(black picture).

A: Please confirm whether the computer configuration meets the following conditions, if not, please select one of the following methods 6.1)-6.5) for testing:

Windows:

CPU:i5 and above

Memory:8 GB or more

Operating System: Windows 10 64 bit processor or above

Graphics: Support Direct X9 128M or above (open AERO effect)

Hard disk space: Above 16G (primary partitions, NTFS format)

Connector: USB 3.0 or type c

Others: do not run multiple video capture or editing software simultaneously

MAC:

CPU: i5 and above

Connector: USB 3.0 or type c

Operating System: macOS 11.0 Big Sur or later macOS 10.15 Catalina

Others: do not run multiple video capture or editing software simultaneously

6.1)Or use typeC to USB3.0 hub to connect the computer and mini-mx

6.2)Or use USB software->ProcessControl_1.0.0.2 to improve performance of computer(in the attachment)

6.3)Lower the output resolution

6.4)Unplug and plug the USB3.0 cable and re-enter the streaming software.

6.5)Change the USB2.0 cable to do streaming (note that the picture quality is lower than the USB3.0 cable, and the USB2.0 cable is not recommended to use the PVW output)

7. Does mini-mx support HDCP?

A: The HDMI input supports the HDCP protocol, HDMI input 1 port supports HDCP2.X, the other input ports support HDCP1.X, and the output does not support HDCP protocol encryption

8. mini-mx HDMI input what kind of YUV.

A: mini-mx supports 4:4:4, not supports 4:2:0.

9. When mini-mx input is i format signal will be half-screened or cut with the P format signal, the height of the P format will be cut.

A : At present, the latest program can automatically determine the i/P signal source and automatically adjust the cropping value.

10. Can mini-mx control PTZ of Pelco protocol?

A: Currently, the PTZ controlling this protocol is not supported, mini-mx supports to control Visca protocol PTZ.

11. Insert USB disk for recording into mini-mx, mini-mx turns into black screen?

A: It means that the USB disk is in a read-only state, please use computer to unlock the USB disk.

12. Connection is normal but failed to search or recognize the camera?

A: 12.1) Connect the switch to the computer.



12.2) Press the "Windows" key and the "R" key to open the "Run" dialog box. Type "cmd" and click the "OK" .

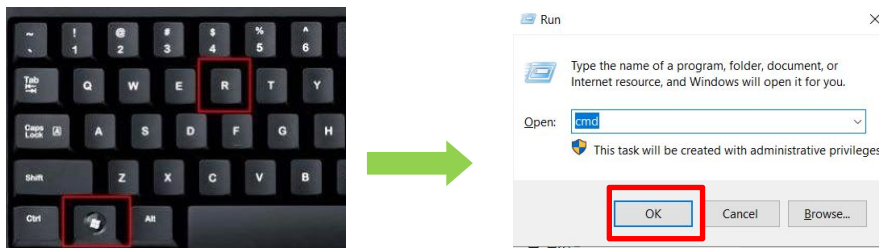

12.3) Enter "ping + IP address" , for example, "ping 192.168.5.66". If the interface shows "Destination host unreachable," it means that the IP has not been occupied.

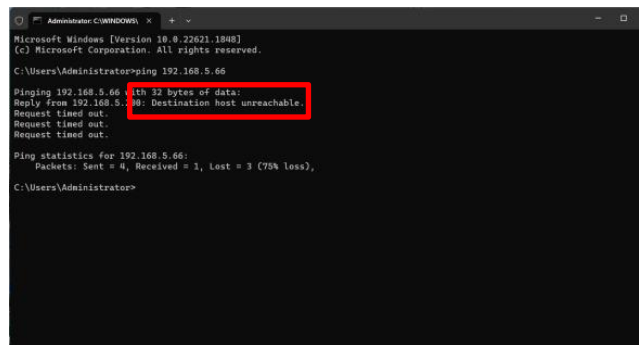

12.4) Then enter "ping 192.168.5.66" in the "Run" dialog box again. Press "Enter" on the keyboard to access this IP address.

```
Request timed out.
Ping statistics for 192.168.5.66:
    Packets: Sent = 4, Received = 1, Lost = 3 (75% loss),
C:\Users\Administrator>ping 192.168.5.66
Pinging 192.168.5.66 with 32 bytes of data:
Request timed out.
Request timed out.
Request timed out.
Ping statistics for 192.168.5.66:
    Packets: Sent = 4, Received = 0, Lost = 4 (100% loss),
C:\Users\Administrator>ping 192.168.5.66
Pinging 192.168.5.66 with 32 bytes of data:
Reply from 192.168.5.66: bytes=32 time=1ms TTL=64
Reply from 192.168.5.66: bytes=32 time=1ms TTL=64
Reply from 192.168.5.66: bytes=32 time=1ms TTL=64
Reply from 192.168.5.66: bytes=32 time=1ms TTL=64
Ping statistics for 192.168.5.66:
    Packets: Sent = 4, Received = 4, Lost = 0 (0% loss),
    Minimum = 1ms, Maximum = 1ms, Average = 1ms
C:\Users\Administrator>
```

13. Video playing via fifth input?

A: The fifth input supports video playing only in .mp4 format and 1080p resolution.

14. How to use stands?

A: 14.1) Tear off the white protective film on the back;



14.2) Attach the adhesive area to mini-mx to provide support and reduce device temperature.



5.3 Upgrade

5.3.1 U Disk Upgrade

Tool: USB disk(copy the firmware to the root directory of USB disk)

Approaches for upgrade guideline:

1) Website

<https://rgblink-web.azurewebsites.net/productsinfo.aspx?id=252>

2) Dropbox

<https://www.dropbox.com/scl/fo/h8vbhed05btgwruhyiqrg/h?dl=0&rlkey=00qqa2wmtqe0987m5ulev9uxc>



Warning:

- 1.mini-mx only supports some models of hard disks. It is recommended to upgrade mini-mx with U disk in FAT32 format. U disk supports USB 2.0 and USB 3.0. Partitioned USB disk not supported.
- 2.Do not power off during the upgrade process, otherwise mini-mx may be unable to enter the system after booting.
- 3.If the version is V1.0.27 and before, please upgrade the old version to V1.0.27 before upgrading the new version.
- 4.For firmware version after V1.0.29, a factory reset is required after first successful upgrade.

Steps:

1.Copy upgrade package to root directory of USB disk.

 MINI-MX_PACKAGE_RELEASE_V1.0.36_230621

2.Power on the device and connect USB disk to USB-C port labeled number 1 by an OTG cable.



3. Tap **【About】** in **【SETTING】** menu to enter the interface below.

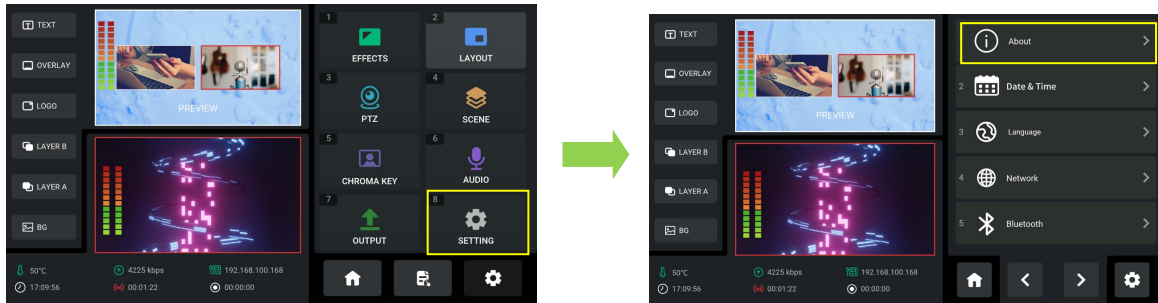

4. Tap **【Device Version】** to check current system version and upgrade file version imported via USB disk; tap **【Upgrade Files】** to enter file list:

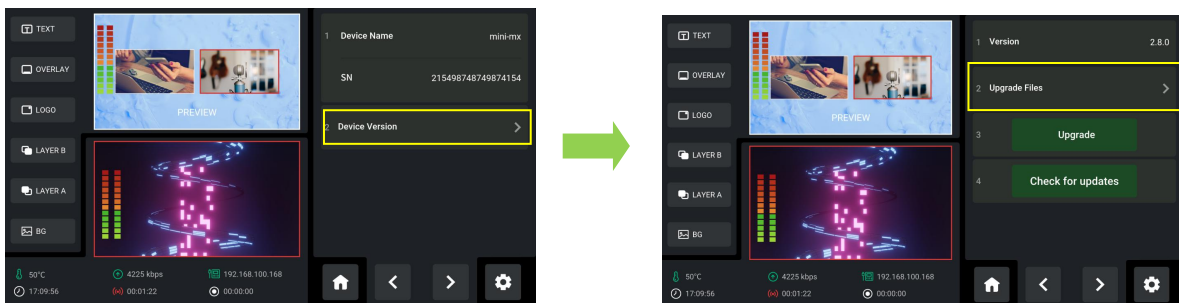

5. Choose the file and then tap Upgrade.

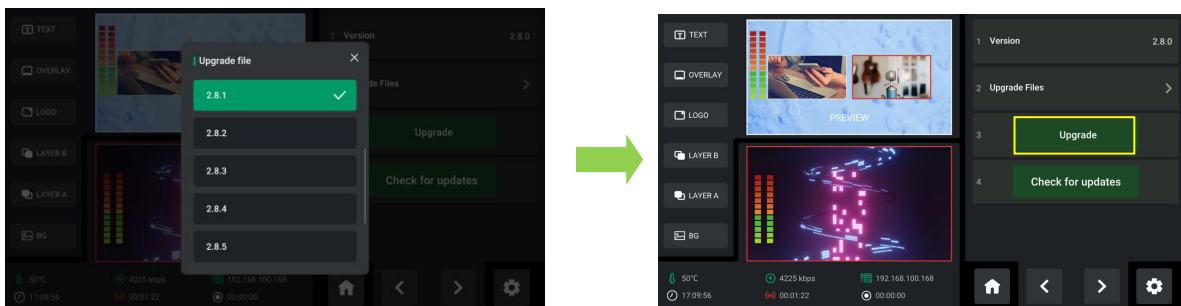

6. The upgrade interface is shown as below. Please **DO NOT** power off during upgrade. mini-mx will reboot after upgrade is completed.

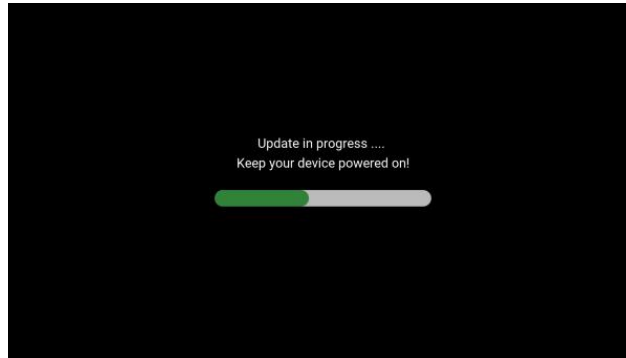

7. Check the new version in the following interface.

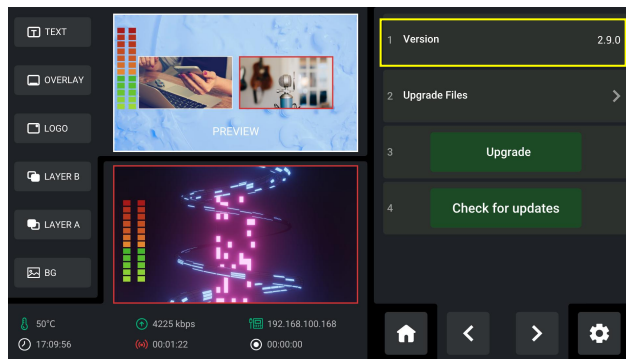

5.3.2 Online Upgrade

Upgrade Method: online upgrade

Steps:

1. Connect mini-mx and your PC via an Ethernet cable;

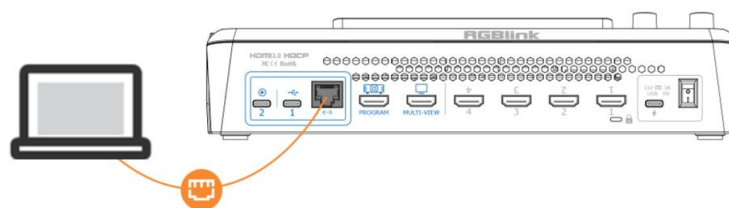

2. Open Network Settings on your PC and ensure that the PC has connected to the local area network where the device is located (such as enable DHCP to for auto IP address capture);

3. Tap **【SETTING】** > **【About】** > **【Device Version】** one by one.

4. For no new version available, press **【 Check for updates 】** , then the interface will display

"Currently in the latest version".

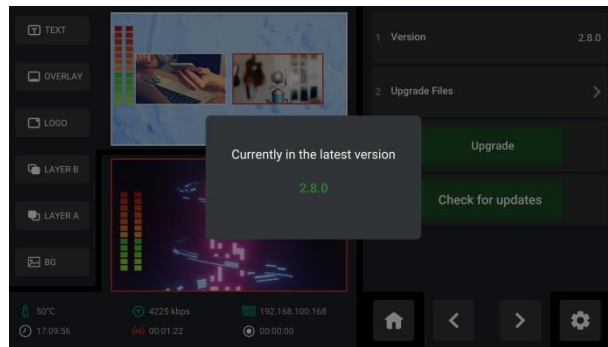

5. "New Version Available" indicates that new version has been captured.

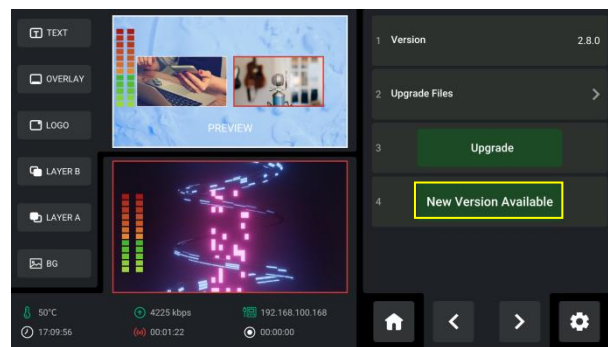

6. Tap **【New Version Available】** to check the new version discovered. Choose **【Download and update】** to download the firmware.

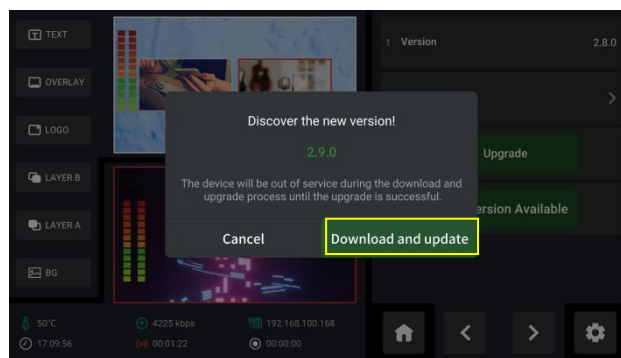

7. It takes about 10 minutes to download the file (depending on the network).

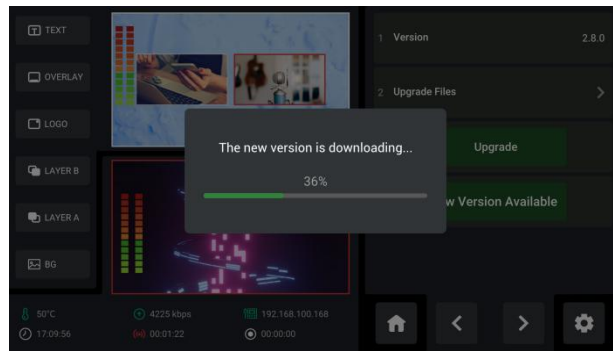

8. Rotate ENTER knob to move the cursor to **【Confirm】** , then press the knob again to perform the upgrade process.

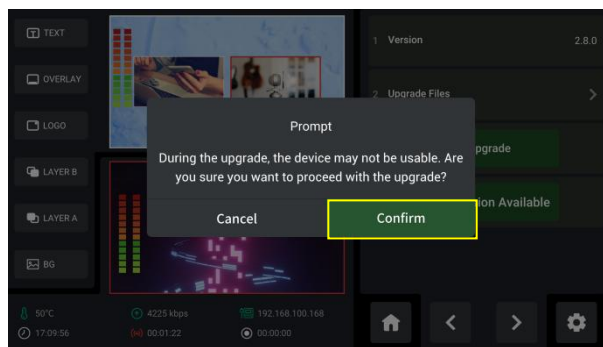

9. DO NOT power off during upgrade process. mini-edge will reboot after upgrade is completed.

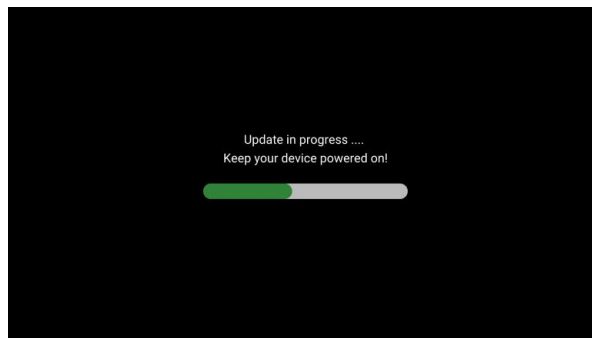

10. Check the new version in the following interface.

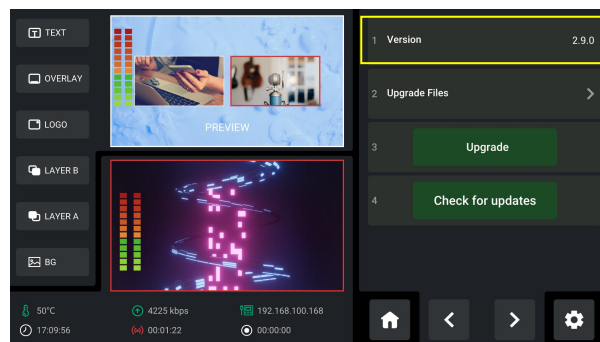

5.4 Terms & Definitions

- **RCA:** Connector used primarily in consumer AV equipment for both audio and video. The RCA connector was developed by the Radio Corporation of America.
- **BNC:** Stands for Bayonet Neill-Concelman. A cable connector used extensively in television (named for its inventors). A cylindrical bayonet connector that operates with a twist-locking motion .
- **CVBS:** CVBS or Composite video, is an analog video signal without audio. Most commonly CVBS is used for transmission of standard definition signals. In consumer applications the connector is typically RCA type, while in professional applications the connector is BNC type.
- **YPbPr:** Used to describe the colour space for progressive-scan. Otherwise known as component video.
- **VGA:** Video Graphics Array. VGA is an analog signal typically used on earlier computers. The signal is non-interlaced in modes 1, 2, and 3 and interlaced when using in mode.
- **DVI:** Digital Visual Interface. The digital video connectivity standard that was developed by DDWG (Digital Display Work Group). This connection standard offers two different connectors: one with 24 pins that handles digital video signals only, and one with 29 pins that handles both digital and analog video.
- **SDI:** Serial Digital Interface. Standard definition video is carried on this 270 Mbps data transfer rate. Video pixels are characterized with a 10-bit depth and 4:2:2 color quantization. Ancillary data is included on this interface and typically includes audio or other metadata. Up to sixteen audio channels can be transmitted. Audio is organised into blocks of 4 stereo pairs. Connector is BNC.
- **HD-SDI:** High-definition serial digital interface (HD-SDI), is standardized in SMPTE 292M this provides a nominal data rate of 1.485 Gbit/s.
- **3G-SDI:** Standardized in SMPTE 424M, consists of a single 2.970 Gbit/s serial link that allows replacing dual link HD-SDI.
- **6G-SDI:** Standardized in SMPTE ST-2081 released in 2015, 6Gbit/s bitrate and able to support 2160p@30.
- **12G-SDI:** Standardized in SMPTE ST-2082 released in 2015, 12Gbit/s bitrate and able to support 2160p@60.
- **U-SDI:** Technology for transmitting large-volume 8K signals over a single cable. a signal interface called the ultra high definition signal/data interface (U-SDI) for transmitting 4K and 8K signals using a single optical cable. The interface was standardized as the SMPTE ST 2036-4.
- **HDMI:** High Definition Multimedia Interface: An interface used for the transmission of uncompressed high definition video, up to 8 channels of audio, and control signals, over a single cable.
- **HDMI 1.3:** Released on June 22 2006, and increased the maximum TMDS clock to 340 MHz (10.2 Gbit/s).

Support resolution 1920 × 1080 at 120 Hz or 2560 × 1440 at 60 Hz). It added support for 10 bpc, 12 bpc, and 16 bpc color depth (30, 36, and 48 bit/px), called deep color.

● **HDMI 1.4:** Released on June 5, 2009, added support for 4096 × 2160 at 24 Hz, 3840 × 2160 at 24, 25, and 30 Hz, and 1920 × 1080 at 120 Hz. Compared to HDMI 1.3, 3 more features added which are HDMI Ethernet Channel (HEC), audio return channel (ARC), 3D Over HDMI, a new Micro HDMI Connector, an expanded set of color spaces.

● **HDMI 2.0:** Released on September 4, 2013 increases the maximum bandwidth to 18.0 Gbit/s. Other features of HDMI 2.0 include up to 32 audio channels, up to 1536 kHz audio sample frequency, the HE-AAC and DRA audio standards, improved 3D capability, and additional CEC functions.

● **HDMI 2.0a:** Was released on April 8, 2015, and added support for High Dynamic Range (HDR) video with static metadata.

● **HDMI 2.0b:** Was released March, 2016, support for HDR Video transport and extends the static metadata signaling to include Hybrid Log-Gamma (HLG).

● **HDMI 2.1:** Released on November 28, 2017. It adds support for higher resolutions and higher refresh rates, Dynamic HDR including 4K 120 Hz and 8K 120 Hz.

● **DisplayPort:** A VESA standard interface primarily for video, but also for audio, USB and other data. DisplayPort (or DP) is backwards compatible with HDMI, DVI and VGA.

● **DP 1.1:** Was ratified on 2 April 2007, and version 1.1a was ratified on 11 January 2008. DisplayPort 1.1 allow a maximum bandwidth of 10.8 Gbit/s (8.64 Gbit/s data rate) over a standard 4-lane main link, enough to support 1920x1080@60Hz

● **DP 1.2:** Introduced on 7 January 2010, effective bandwidth to 17.28 Gbit/s support increased resolutions, higher refresh rates, and greater color depth, maximum resolution 3840 × 2160@60Hz

● **DP 1.4:** Publish on 1 Mar, 2016. overall transmission bandwidth 32.4 Gbit/s, DisplayPort 1.4 adds support for Display Stream Compression 1.2 (DSC), DSC is a "visually lossless" encoding technique with up to a 3:1 compression ratio. Using DSC with HBR3 transmission rates, DisplayPort 1.4 can support 8K UHD (7680 × 4320) at 60 Hz or 4K UHD (3840 × 2160) at 120 Hz with 30 bit/px RGB color and HDR. 4K at 60 Hz 30 bit/px RGB/HDR can be achieved without the need for DSC.

● **Multi-mode Fiber:** Fibers that support many propagation paths or transverse modes are called multi-mode fibers, generally have a wider core diameter and are used for short-distance communication links and for applications where high power must be transmitted.

● **Single-mode Fiber:** Fiber that support a single mode are called single-mode fibers. Single-mode fibers are used for most communication links longer than 1,000 meters (3,300 ft).

● **SFP:** Small form-factor pluggable , is a compact, hot-pluggable network interface module used for both telecommunication and data communications applications.

● **Optical Fiber Connector:** Terminates the end of an optical fiber, and enables quicker connection and disconnection than splicing. The connectors mechanically couple and align the cores of fibers so light can pass. 4 most common types of optical fiber connectors are SC, FC, LC,ST.

● **SC:** (Subscriber Connector), also known as the square connector was also created by the Japanese company – Nippon Telegraph and Telephone. SC is a push-pull coupling type of connector and has a 2.5mm diameter. Nowadays, it is used mostly in single mode fiber optic patch cords, analog, GBIC, and CATV. SC is one of the most popular options, as its simplicity in design comes along with great durability and affordable prices.

● **LC:** (Lucent Connector) is a small factor connector (uses only a 1.25mm ferrule diameter) that has a snap coupling mechanism. Because of its small dimensions, it is the perfect fit for high-density connections, XFP, SFP, and SFP+ transceivers.

● **FC:** (Ferrule Connector) is a screw type connector with a 2.5mm ferrule. FC is a round shaped threaded fiber optic connector,mostly used on Datacom, telecom, measurement equipment, single-mode laser.

● **ST:** (Straight Tip) was invented by AT&T and uses a bayonet mount along with a long spring-loaded ferrule to support the fiber.









● **USB:** Universal Serial Bus is a standard that was developed in the mid-1990s that defines cables, connectors and communication protocols. This technology is designed to allow a connection, communication and power supply for peripheral devices and computers.

● **USB 1.1:** Full-Bandwidth USB, specification was the first release to be widely adopted by the consumer market. This specification allowed for a maximum bandwidth of 12Mbps.

● **USB 2.0:** or Hi-Speed USB, specification made many improvements over USB 1.1. The main improvement was an increase in bandwidth to a maximum of 480Mbps.

● **USB 3.2:** Super Speed USB with 3 varieties of 3.2 Gen 1(original name USB 3.0), 3.2Gen 2(original name USB 3.1), 3.2 Gen 2x2 (original name USB 3.2) with speed up to 5Gbps,10Gbps,20Gbps respectively.

USB version and connectors figure:

	Type A	Type B	Mini A	Mini B	Micro-A	Micro-B	Type C
USB 2.0							
USB 3.0							

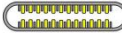
USB 3.1&3.2							
----------------	--	--	--	--	--	--	--

- **NTSC:** The colour video standard used in North America and some other parts of the world created by the National Television Standards Committee in the 1950s. NTSC utilizes an interlaced video signals.
- **PAL:** Phase Alternate Line. A television standard in which the phase of the colour carrier is alternated from line to line. It takes four full images (8 fields) for the colour-to-horizontal images (8 fields) for the colour-to-horizontal phase relationship to return to the reference point. This alternation helps cancel out phase errors. For this reason, the hue control is not needed on a PAL TV set. PAL, is widely used in Western Europe, Australia, Africa, the Middle East, and Micronesia. PAL uses 625-line, 50-field (25 fps) composite colour transmission system.
- **SMPTE:** Society of Motion image and Television Engineers. A global organization, based in the United States, that sets standards for baseband visual communications. This includes film as well as video and television standards.
- **VESA:** Video Electronics Standards Association. An organization facilitating computer graphics through standards.
- **HDCP:** High-bandwidth Digital Content Protection (HDCP) was developed by Intel Corporation and is in wide use for protection of video during transmission between devices.
- **HDBaseT:** A video standard for the transmission of uncompressed video (HDMI signals) and related features using Cat 5e/Cat6 cabling infrastructure.
- **ST2110:** A SMPTE developed standard, ST2110 describes how to send digital video over and IP networks. Video is transmitted uncompressed with audio and other data in a separate streams. SMPTE2110 is intended principally for broadcast production and distribution facilities where quality and flexibility are more important.
- **SDVoE:** Software Defined Video over Ethernet (SDVoE) is a method for transmission, distribution and management AV signals using a TCP/IP Ethernet infrastructure for transport with low latency. SDVoE is commonly used in integration applications.
- **Dante AV:** The Dante protocol was developed for and widely adopted in audio systems for the transmission of uncompressed digital audio on IP based networks. The more recent Dante AV specification includes support for digital video.
- **NDI:** Network Device interface (NDI) is a software standard developed by NewTek to enable video-compatible products to communicate, deliver, and receive broadcast quality video in a high quality, low latency manner that is frame-accurate and suitable for switching in a live production environment over TCP (UDP) Ethernet based

networks. NDI is commonly found in broadcast applications.

● **RTMP:** Real-Time Messaging Protocol (RTMP) was initially a proprietary protocol developed by Macromedia (now Adobe) for streaming audio, video and data over the Internet, between a Flash player and a server.

● **RTSP:** The Real Time Streaming Protocol (RTSP) is a network control protocol designed for use in entertainment and communications systems to control streaming media servers. The protocol is used for establishing and controlling media sessions between end points.

● **MPEG:** Moving Picture Experts Group is a working group formed from ISO and IEC developing standards that allow audio/video digital compression and Transmission.

● **H.264:** Also known as AVC (Advanced Video Coding) or MPEG-4i is a common video compression standard. H.264 was standardized by the ITU-T Video Coding Experts Group (VCEG) together with the ISO/IEC JTC1 Moving Picture Experts Group (MPEG).

● **H.265:** Also known as **HEVC** (High Efficiency Video Coding) H.265 is the successor to the widely used H.264/AVC digital video coding standard. Developed under the auspices of ITU, resolutions up to 8192x4320 may be compressed.

● **API:** An Application Programming Interface (API) provides a predefined function which allows access capabilities and features or routines via a software or hardware, without accessing source code or understanding the details of inner working mechanism. An API call may execute a function and/or provide data feedback/report.

● **DMX512:** The communication standard developed by USITT for entertainment and digital lighting systems. The wide adoption of the Digital Multiplex (DMX) protocol has seen the protocol used for a wide range of other devices including video controllers. DMX512 is delivered over cable of 2 twisted pairs with 5pin XLR cables for connection.

● **ArtNet:** An ethernet protocol based on TCP/IP protocol stack, mainly used in entertainment/events applications. Built on the DMX512 data format, ArtNet enables multiple “universes” of DMX512 to be transmitted using ethernet networks for transport.

● **MIDI:** MIDI is the abbreviation of Musical Instrument Digital Interface. As the name indicates the protocol was developed for communication between electronic musical instruments and latterly computers. MIDI instructions are triggers or commands sent over twisted pair cables, typically using 5pin DIN connectors.

● **OSC:** The principle of Open Sound Control (OSC) protocol is for networking sound synthesizers, computers, and multimedia devices for musical performance or show control. As with XML and JSON, the OSC protocol allows sharing data. OSC is transported via UDP packets between devices connected on an Ethernet.

-
- **Brightness:** Usually refers to the amount or intensity of video light produced on a screen without regard to colour. Sometimes called black level.
 - **Contrast Ratio:** The ratio of the high light output level divided by the low light output level. In theory, the contrast ratio of the television system should be at least 100:1, if not 300:1. In reality, there are several limitations. Well-controlled viewing conditions should yield a practical contrast ratio of 30:1 to 50:1.
 - **Colour Temperature:** The colour quality, expressed in degrees Kelvin (K), of a light source. The higher the colour temperature, the bluer the light. The lower the temperature, the redder the light. Benchmark colour temperature for the A/V industry include 5000°K, 6500°K, and 9000°K.
 - **Saturation:** Chroma, Chroma gain. The intensity of the colour, or the extent to which a given colour in any image is free from white. The less white in a colour, the truer the colour or the greater its saturation. Saturation is the amount of pigment in a colour, and not the intensity.
 - **Gamma:** The light output of a CRT is not linear with respect to the voltage input. The difference between what you should have and what is actually output is known as gamma.
 - **Frame:** In interlaced video, a frame is one complete image. A video frame is made up of two fields, or two sets of interlaced lines. In a film, a frame is one still image of a series that makes up a motion image.
 - **Genlock:** Allows synchronisation of otherwise video devices. A signal generator provides a signal pulses which connected devices can reference. Also see Black Burst and Color Burst.
 - **Blackburst:** The video waveform without the video elements. It includes the vertical sync, horizontal sync, and the Chroma burst information. Blackburst is used to synchronize video equipment to align the video output.
 - **Colour Burst:** In colour TV systems, a burst of subcarrier frequency located on the back part of the composite video signal. This serves as a colour synchronizing signal to establish a frequency and phase reference for the Chroma signal. Colour burst is 3.58 MHz for NTSC and 4.43 MHz for PAL.
 - **Colour Bars:** A standard test pattern of several basic colours (white, yellow, cyan, green, magenta, red, blue, and black) as a reference for system alignment and testing. In NTSC video, the most commonly used colour bars are the SMPTE standard colour bars. In PAL video, the most commonly used colour bars are eight full field bars. On computer monitors the most commonly used colour bars are two rows of reversed colour bars
 - **Seamless Switching:** A feature found on many video switchers. This feature causes the switcher to wait until the vertical interval to switch. This avoids a glitch (temporary scrambling) which often is seen when switching between

sources.

- **Scaling:** A conversion of a video or computer graphic signal from a starting resolution to a new resolution. Scaling from one resolution to another is typically done to optimize the signal for input to an image processor, transmission path or to improve its quality when presented on a particular display.
- **PIP:** Picture-In-Picture. A small image within a larger image created by scaling down one of image to make it smaller. Other forms of PIP displays include Picture-By-Picture (PBP) and Picture- With-Picture (PWP), which are commonly used with 16:9 aspect display devices. PBP and PWP image formats require a separate scaler for each video window .
- **HDR:** is a high dynamic range (HDR) technique used in imaging and photography to reproduce a greater dynamic range of luminosity than what is possible with standard digital imaging or photographic techniques. The aim is to present a similar range of luminance to that experienced through the human visual system.
- **UHD:** Standing for Ultra High Definition and comprising 4K and 8K television standards with a 16:9 ratio, UHD follows the 2K HDTV standard. A UHD 4K display has a physical resolution of 3840x2160 which is four times the area and twice both the width and height of a HDTV/FullHD (1920x1080) video signal.
- **EDID:** Extended Display Identification Data. EDID is a data structure used to communicate video display information, including native resolution and vertical interval refresh rate requirements, to a source device. The source device will then output the provided EDID data, ensuring proper video image quality.

5.5 Revision History

The table below lists the changes to the User Manual.

Format	Time	ECO#	Description	Principal
V1.0	2023-03-28	0000#	Release	Aster
V1.1	2023-04-21	0001#	Add upgrade guidance	Aster
V1.2	2023-06-08	0002#	1. Update device silkscreen 2. Add preview interface introduction 3. Update audio setting interface 4. Add System Setting 5. Add weight parameters	Aster
V1.3	2023-06-29	0003#	1. Update operations for PTZ control 2. Update IP setting interface 3. Add mobile phone network share function 4. Revise upgrade guidance	Aster
V1.4	2023-07-20	0004#	Update user interface	Aster

V1.5	2023-08-01	0005#	<ol style="list-style-type: none"> 1. Update operations for PTZ control 2. Update streaming operations 3. Revise upgrading guidance 4. Add operations on how to add layers 	Aster
V1.6	2023-09-22	0006#	<ol style="list-style-type: none"> 1. Rename Preview Interface to Main Interface; rename Main Interface to Editing Interface 2. Update operations of front panel buttons 3. Update operations of Preview Interface, Main Interface and Editing Interface 4. Update SETTING interface 5. Add microphone selection and level setting on Audio 	Aster
V1.7	2023-11-07	0007#	Add PIP and Chroma Key	Aster
V1.8	2023-11-17	0008#	<ol style="list-style-type: none"> 1. Add Views Auto Loop and USB2 Mode 2. Update interface of Recording, Date & Time, Bluetooth 	Aster
V1.9	2024-04-10	0009#	Add VFA and Scoreboard function	Aster
V2.0	2024-05-06	0010#	<ol style="list-style-type: none"> 1. Add Transition Effect illustration 2. Add notes for USB upgrade and video playing 3. Add Color Management Setting for HDMI inputs 	Aster
V2.1	2024-06-13	0011#	Revise Upgrade steps	Aster

All information herein is Xiamen RGBlink Science & Technology Co Ltd. excepting noted.

RGBlink is a registered trademark of Xiamen RGBlink Science & Technology Co Ltd.

While all efforts are made for accuracy at time of printing, we reserve the right to alter otherwise make change without notice.

Chapter 6 Support

www.rgblink.com



Inquiries

+86-592-577-1197
info@rgblink.com
rgblink.com/contact-us

Global Support

support@rgblink.com
rgblink.com/support-me



@RGLINK



/rgblink



+rgblink



/rgblink



rgblink



rgblink

RGBlink Headquarters Xiamen, China

Room 601A, No. 37-3
Banshang community,
Building 3, Xinke Plaza, Torch
Hi-Tech Industrial
Development Zone, Xiamen,
China

+86-592-577-1197

China Regional Sales & Support Shenzhen, China

705, 7th Floor, South District,
Building 2B, Skyworth
Innovation Valley, No. 1
Tangtou Road, Shiyan Street,
Baoan District, Shenzhen City,
Guangdong Province

+86-755 2153 5149

Beijing Region Office Beijing, China

Building 8, 25 Qixiao Road
Shahe Town Changping

+010- 8577 7286

Europe Regional Sales & Support Eindhoven, Holland

Flight Forum Eindhoven
5657 DW

+31 (040) 202 71 83