

ASK plus p2p

4K Wireless HDMI Extender



User Manual

RGBlink[®]

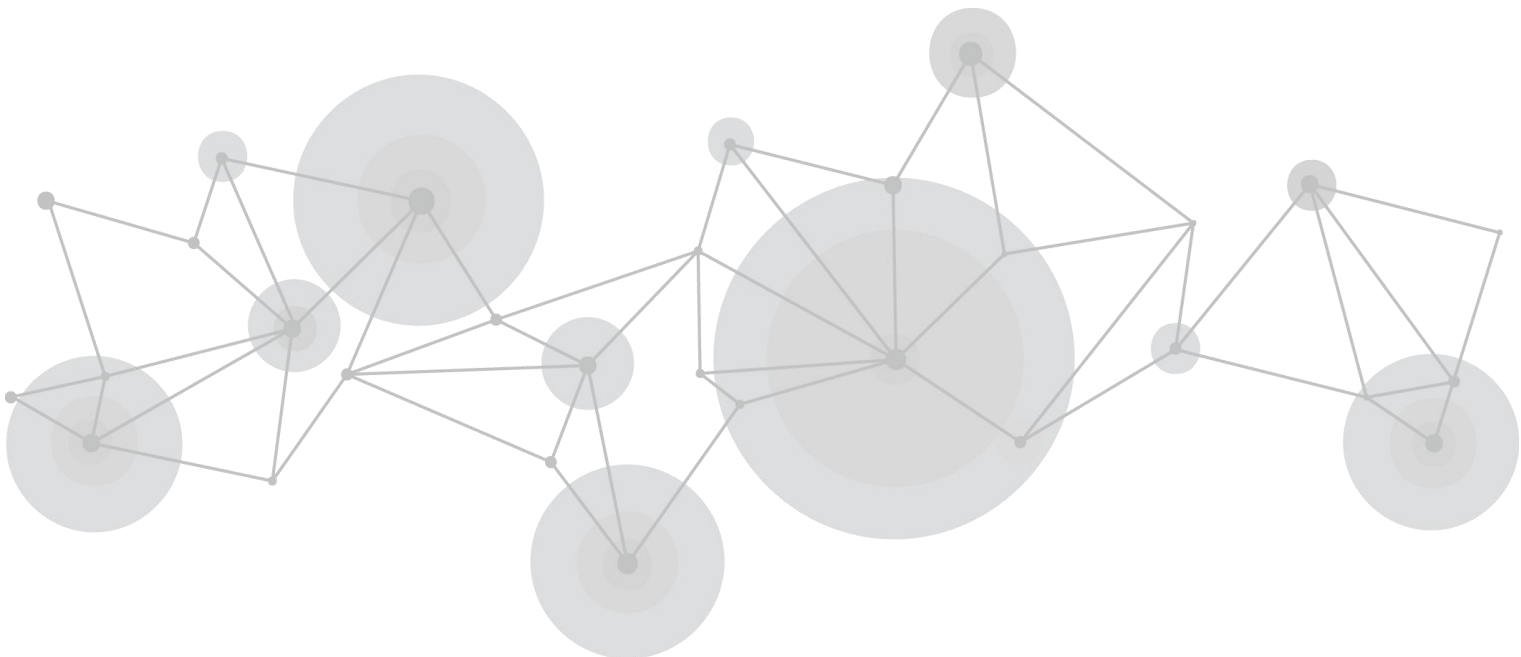

Article No: RGB-RD-UM-ASK plus p2p E000
Revision No: V1.0

Content

Declarations	2
FCC/Warranty	2
Operators Safety Summary	3
Installation Safety Summary	3
Chapter 1 Your Product	5
1.1 In the Box	5
1.2 Product Overview	5
1.2.1 Key Features	5
1.2.2 Interface	6
1.2.3 Dimensions	7
Chapter 2 Use Your Product	8
2.1 Pairing of TX and RX	8
2.2 Installation Guide	8
2.2.1 Connecting the Transmitter	8
2.2.2 Connecting the Receiver	9
2.3 Connecting the USB Extension	9
2.4 Testing the USB Extension Function	10
Chapter 3 Order Codes	11
Chapter 4 Support	12
4.1 Contact us	12
Chapter 5 Appendix	13
5.1 FAQ	13
5.2 Specification	14
5.3 Terms & Definitions	14
5.4 Revision History	22

Thank you for choosing our product!

This User Manual is designed to show you how to use this product quickly and make use of all the features. Please read all directions and instructions carefully before using this product.

Declarations

FCC/Warranty

Federal Communications Commission (FCC) Statement

This equipment has been tested and found to comply with the limits for a class A digital device, pursuant to Part 15 of the FCC rules. These limits are designed to provide reasonable protection against harmful interference when the equipment is operated in a commercial environment. This equipment generates, uses, and can radiate radio frequency energy and, if not installed and used in accordance with the instruction manual, may cause harmful interference to radio communications. Operation of this equipment in a residential area may cause harmful interference, in which case the user will be responsible for correcting any interference.

Guarantee and Compensation

RGBlink provides a guarantee relating to perfect manufacturing as part of the legally stipulated terms of guarantee. On receipt, the purchaser must immediately inspect all delivered goods for damage incurred during transport, as well as for material and manufacturing faults. RGBlink must be informed immediately in writing of any complains.

The period of guarantee begins on the date of transfer of risks, in the case of special systems and software on the date of commissioning, at latest 30 days after the transfer of risks. In the event of justified notice of compliant, RGBlink can repair the fault or provide a replacement at its own discretion within an appropriate period. If this measure proves to be impossible or unsuccessful, the purchaser can demand a reduction in the purchase price or cancellation of the contract. All other claims, in particular those relating to compensation for direct or indirect damage, and also damage attributed to the operation of software as well as to other service provided by RGBlink, being a component of the system or independent service, will be deemed invalid provided the damage is not proven to be attributed to the absence of properties guaranteed in writing or due to the intent or gross negligence or part of RGBlink.

If the purchaser or a third party carries out modifications or repairs on goods delivered by RGBlink, or if the goods are handled incorrectly, in particular if the systems are commissioned operated incorrectly or if, after the transfer of risks, the goods are subject to influences not agreed upon in the contract, all guarantee claims of the purchaser will be rendered invalid. Not included in the guarantee coverage are system failures which are attributed to programs or special electronic circuitry provided by the purchaser, e.g. interfaces. Normal wear as well as normal maintenance are not subject to the guarantee provided by RGBlink either.

The environmental conditions as well as the servicing and maintenance regulations specified in this manual must be complied with by the customer.

Operators Safety Summary

The general safety information in this summary is for operating personnel.

Do Not Remove Covers or Panels

There are no user-serviceable parts within the unit. Removal of the top cover will expose dangerous voltages. To avoid personal injury, do not remove the top cover. Do not operate the unit without the cover installed.

Power Source

This product is intended to operate from a power source that will not apply more than 230 volts rms between the supply conductors or between both supply conductor and ground. A protective ground connection by way of grounding conductor in the power cord is essential for safe operation.

Grounding the Product

This product is grounded through the grounding conductor of the power cord. To avoid electrical shock, plug the power cord into a properly wired receptacle before connecting to the product input or output terminals. A protective-ground connection by way of the grounding conductor in the power cord is essential for safe operation.

Use the Proper Power Cord

Use only the power cord and connector specified for your product. Use only a power cord that is in good condition. Refer cord and connector changes to qualified service personnel.

Use the Proper Fuse

To avoid fire hazard, use only the fuse having identical type, voltage rating, and current rating characteristics. Refer fuse replacement to qualified service personnel.

Do Not Operate in Explosive Atmospheres

To avoid explosion, do not operate this product in an explosive atmosphere.

Installation Safety Summary

Safety Precautions

For all device installation procedures, please observe the following important safety and handling rules to avoid damage to yourself and the equipment.

To protect users from electric shock, ensure that the chassis connects to earth via the ground

wire provided in the AC power Cord.

The AC Socket-outlet should be installed near the equipment and be easily accessible.

Unpacking and Inspection

Before opening device shipping box, inspect it for damage. If you find any damage, notify the shipping carrier immediately for all claims adjustments. As you open the box, compare its contents against the packing slip. If you find any shortages, contact your sales representative. Once you have removed all the components from their packaging and checked that all the listed components are present, visually inspect the system to ensure there was no damage during shipping. If there is damage, notify the shipping carrier immediately for all claims adjustments.

Site Preparation

The environment in which you install your device should be clean, properly lit, free from static, and have adequate power, ventilation, and space for all components.

Chapter 1 Your Product

1.1 In the Box

3 * USB A -USB-C Power Cable

3 * 5V 2A USB Power Adapter

1 * micro USB Cable

1.2 Product Overview

ASK plus p2p, 4K wireless transmitter and receiver, supports 4K@60 resolution, super smooth playback with 100ms low latency. .

Each TX and RX works point to point in designated channel and up to 20 TX and 20 RX can work simultaneously without interfering each other.

ASK plus p2p allows users to wireless stream the video content without latency, excellent for applications like education or digital signage.

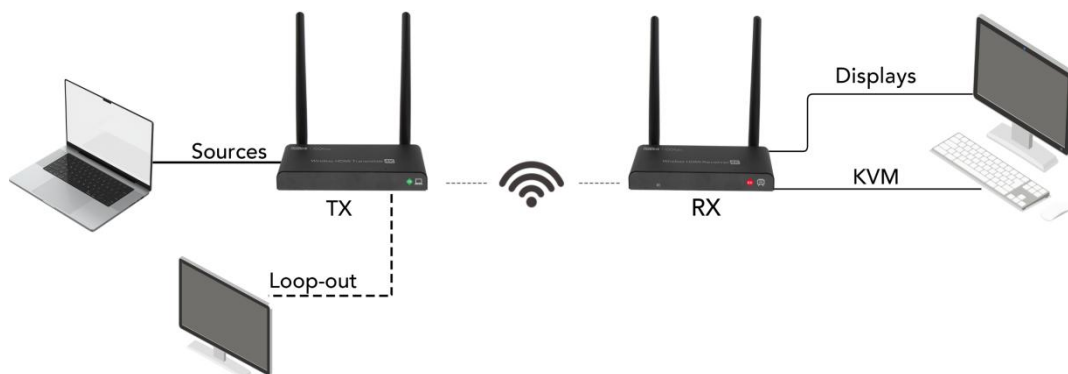

ASK plus p2p System Connection Diagram

1.2.1 Key Features

- Each TX and RX works point to point in designated channel and up to 20 TX and 20 RX can work simultaneously without interfering each other
- Smooth video playback
- Supports 4K@60 high definition resolution
- As low as 100ms latency
- USB KVM function

- Transmission distance up to 150 meters in the clear line of sight for 1*RX
- Touch panel back control function
- Auto channel selection
- Equipped with the fast 802. 11ac 2T2R WiFi MIMO module
- High-security protection
- Suitable for outdoor rotating display

1.2.2 Interface

Transmitter

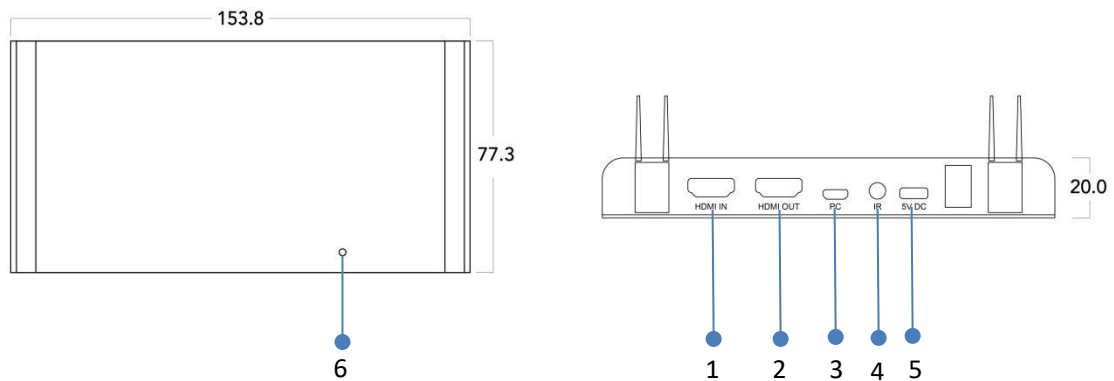

No.	Name	Description
1	HDMI IN	Connect with the video source
2	HDMI OUT	Connect with display for pass-through
3	PC	Connect with USB of video source for KVM function
4	IR Port	Connect with IR probe of video source for IR extended function (to be developed)
5	5V DC	Connect with 5V/2A power adapter
6	LED Indicator	<ul style="list-style-type: none"> • Red: TX system is booting on • Flashing Blue: Waiting for connection • Static Blue: Connected • Purple: No video in

Receiver

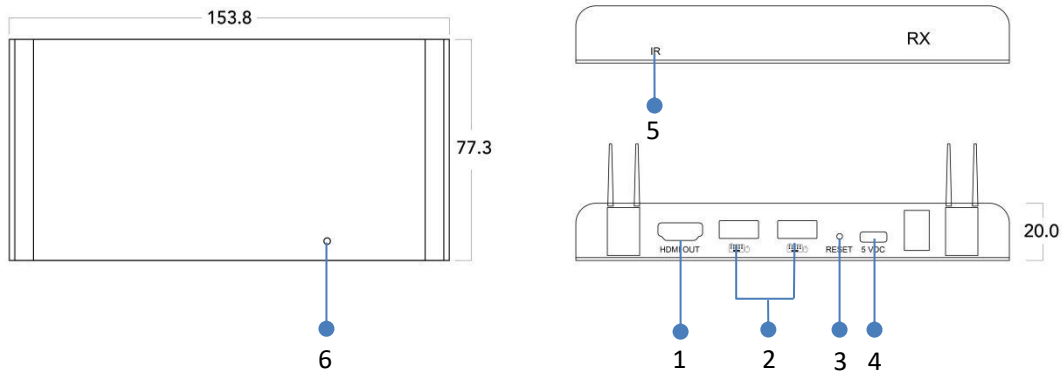

No.	Name	Description
1	HDMI OUT	Connect to display or or projector
2		<ul style="list-style-type: none"> Connect with mouse and keyboard for USB KVM function Connect with touch panel USB port for touch panel back control
3	Reset	Reset to factory
4	5V DC	Connect with 5V/2A power adapter
5	IR Window	IR extended function (to be developed)
6	LED Indicator	<ul style="list-style-type: none"> Flashing Blue: Waiting for connection Static Blue: Connected

1.2.3 Dimensions

Following is the dimension of ASK plus p2p (TX/RX) for your reference:

Dimension: 154.0mm x 77.5mm x 21.0mm

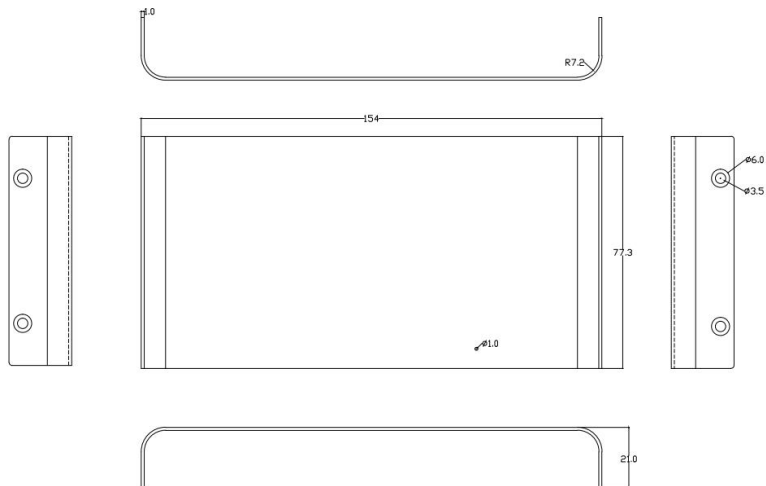

Chapter 2 Use Your Product

2.1 Pairing of TX and RX

Before delivery, each ASK plus p2p set has been paired , but when extra RX is required, following steps are the methods for users to finish TX/RX pairing.

- 1) Power on the transmitter ;
- 2) Power on the receiver till it's on the main menu ;
- 3) Press the receiver's reset button and hold for 10 seconds till the interface shows reset picture;
- 4) Wait around 30 seconds, the transmitter and receiver will pair automatically.

2.2 Installation Guide

2.2.1 Connecting the Transmitter

The transmitter sends the HD video signal wirelessly to the receiver in another room. Therefore, place the transmitter near your HDMI source (for example: set top box, Blu-ray player, Media Player, Media Center PC/laptop).

- 1) Connect the power adapter to the connector marked "5V DC" and insert the plug into the wall socket;
- 2) Use an HDMI cable to connect the HDMI source to the HDMI port marked "HDMI IN" on the TX;
- 3) Optional: To continue watching TV in this room as well, use an HDMI cable (not supplied) to connect a TV to the HDMI port marked "HDMI OUT".

Indicator Status of TX	Description
Red	TX system is booting on
Flashing Blue	Waiting for connection
Static Blue	Connected
Purple	No video in

2.2.2 Connecting the Receiver

- 1) Connect the power adapter to the connector marked "5V DC" and insert the plug into the wall socket;
- 2) Place the receiver in the room where you want to connect the second TV or projector;
- 3) Use an HDMI cable to connect TV or projector to the HDMI port marked "HDMI OUT" on the receiver.

Indicator Status of TX	Description
Flashing Blue	Waiting for connection
Static Blue	Connected

2.3 Connecting the USB Extension

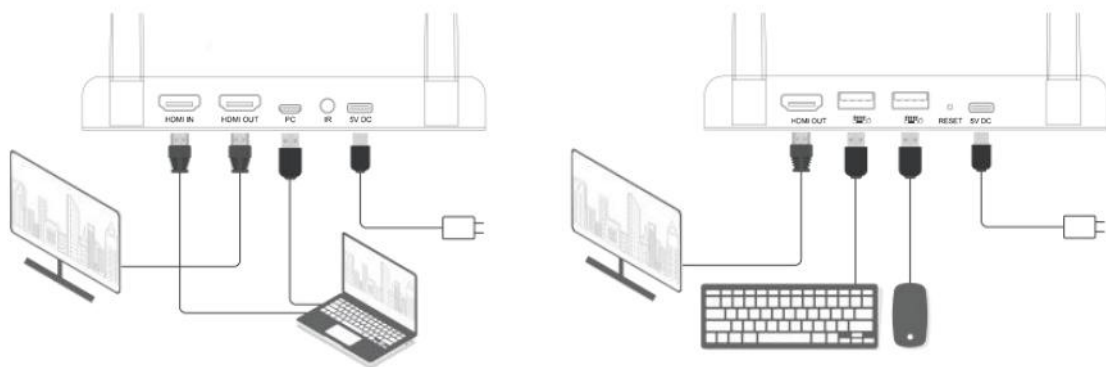

The 4K wireless HDMI extender features a built-in USB extension function, which helps users to continue to operate connected HDMI sources, such as a Media Center PC or laptop, from another room, using a mouse and/or keyboard.

- 1) To the Transmitter:** Using the included Micro USB cable to connect PC or laptop to the Micro USB socket marked "PC" on the transmitter.
- 2) To the Receiver:** Connect mouse and/or keyboard to the connectors marked "  " on the receiver.

2.4 Testing the USB Extension Function

Once users have connected the Micro USB cable and mouse/keyboard according to the above description, it is recommended to test the function first.

- 1) Take a mouse or keyboard and use one of the functions;
- 2) The receiver will now send this function to the transmitter;
- 3) The transmitter will now forward this function to the Media Center PC or laptop;
- 4) The Media Center PC or laptop should now execute the function of the mouse or keyboard.

Chapter 3 Order Codes

Product Code	Item
450-3002-01-1	ASK plus p2p (1*TX + 1*RX)

Chapter 4 Support

4.1 Contact us

www.rgblink.com



Inquiries

+86-592-577-1197
info@rgblink.com
rgblink.com/contact-us

Global Support

support@rgblink.com
rgblink.com/support-me



@RGLINK



/rgblink



+rgblink



/rgblink



rgblink



rgblink

RGblink Headquarters

Xiamen, China

Room 601A, No. 37-3
Banshang community,
Building 3, Xinke Plaza, Torch
Hi-Tech Industrial
Development Zone, Xiamen,
China

+86-592-577-1197

China Regional Sales & Support

Shenzhen, China

705, 7th Floor, South District,
Building 2B, Skyworth
Innovation Valley, No. 1
Tangtou Road, Shiyuan Street,
Baoan District, Shenzhen City,
Guangdong Province

+86-755 2153 5149

Beijing Region Office

Beijing, China

Building 8, 25 Qixiao Road
Shahe Town Changping

+010- 8577 7286

Europe Regional Sales & Support

Eindhoven, Holland

Flight Forum Eindhoven
5657 DW

+31 (040) 202 71 83

Chapter 5 Appendix

5.1 FAQ

1. No (or poor) image and sound on TV or projector.

Move the transmitter and the receiver in the same room to test if the connection works well, and please make sure all of below setting are correct.

- 1) Ensure that the power of the transmitter and receiver is properly connected. Ensure that all HDMI cables are connected properly or replace them;
- 2) Ensure that the HDMI source is turned ON and the correct HDMI input is selected on the TV;
- 3) Ensure that the HDMI source is set to a correct video resolution. If necessary, consult the user manual of your HDMI source;
- 4) Disconnect the power adapters from the wall socket and reconnect them to reboot the 4K wireless HDMI extender.

If the transmitter and receiver still no connection, please follow the below step for pairing.

- 1) Power on the transmitter;
- 2) Power on the receiver till it's on the main screen;
- 3) Press the receiver's reset button and hold for 5 seconds till the LED is flashing fast;
- 4) Wait around 30 seconds, the transmitter and receiver will be paired automatically.

2. No or bad connection between the transmitter and receiver.

- 1) Move the transmitter and/or the receiver from the immediate vicinity of the connected HDMI sources and Wi-Fi equipment. These may affect the range;
- 2) Slightly adjust the position of the transmitter and/or receiver may already help out, decrease the distance between the transmitter and receiver to ensure it is within the available transmission range;
- 3) Disconnect the power adapters from the wall socket and reconnect them to reboot the 4K wireless HDMI extender.

3. I do have picture, but no (or bad) sound.

ASK plus p2p supports up to 2CH PCM stereo.

Check the audio setting in the settings menu of the connected HDMI source and manually set it to 2CH PCM stereo when the automatic setting does not work.

5.2 Specification

Interface	Input	TX	HDMI	1×HDMI -A		
	Output	TX	HDMI	1×HDMI-A		
		RX	HDMI	1×HDMI-A		
	Control	TX	USB	1×Micro-USB (PC)		
			IR	1×IR (to be developed)		
	RX	USB	2×USB-A (keyboard/mouse/touch panel control cable)			
Power	TX	Power	1×USB-C			
	RX	Power	1×USB-C			
Performance	Video Resolutions	SMPTE	4K@60 4K@30 4K@24 1080p@60/50/30/24 720p@60/50/30 480p			
	HDMI Version	HDMI	2.0	HDCP	1.4/2.2	
	Wireless Standard	IEEE 802.11b/g/n/ac, 2.4G/5GHz, 2T2R				
	Platform Supported	Any devices that support HDMI port				
	Latency	About 100ms latency				
	Audio	Stereo, 44.1KHz				
	Distance	About 150 meters in the clear line of sight				
Power	Power Supply	TX	DC 5V/2A	RX	DC 5V/2A	
	Power Consumption	TX	7W	RX	5W	
Environment	Operating Temperature	0°C to +40°C (+32°F to +104°F)				
	Storage Temperature	-10°C to +60°C (+14°F to +140°F)				
	Operating Humidity	10% to 80% RH				
Physical	Net Dimension	TX	154*77.5*21mm	RX	154*77.5*21mm	
	Net Weight	TX	330g	RX	330g	

5.3 Terms & Definitions

● **RCA:** Connector used primarily in consumer AV equipment for both audio and video. The RCA connector was developed by the Radio Corporation of America.

-
- **BNC:** Stands for Bayonet Neill-Concelman. A cable connector used extensively in television (named for its inventors). A cylindrical bayonet connector that operates with a twist-locking motion.

 - **CVBS:** CVBS or Composite video, is an analog video signal without audio. Most commonly CVBS is used for transmission of standard definition signals. In consumer applications the connector is typically RCA type, while in professional applications the connector is BNC type.

 - **YPbPr:** Used to describe the colour space for progressive-scan. Otherwise known as component video.

 - **VGA:** Video Graphics Array. VGA is an analog signal typically used on earlier computers. The signal is non-interlaced in modes 1, 2, and 3 and interlaced when using in mode.

 - **DVI:** Digital Visual Interface. The digital video connectivity standard that was developed by DDWG (Digital Display Work Group). This connection standard offers two different connectors: one with 24 pins that handles digital video signals only, and one with 29 pins that handles both digital and analog video.

 - **SDI:** Serial Digital Interface. Standard definition video is carried on this 270 Mbps data transfer rate. Video pixels are characterized with a 10-bit depth and 4:2:2 color quantization. Ancillary data is included on this interface and typically includes audio or other metadata. Up to sixteen audio channels can be transmitted. Audio is organised into blocks of 4 stereo pairs. Connector is BNC.

 - **HD-SDI:** High-definition serial digital interface (HD-SDI), is standardized in SMPTE 292M this provides a nominal data rate of 1.485 Gbit/s.

 - **3G-SDI:** Standardized in SMPTE 424M, consists of a single 2.970 Gbit/s serial link that allows replacing dual link HD-SDI.

 - **6G-SDI:** Standardized in SMPTE ST-2081 released in 2015, 6Gbit/s bitrate and able to support 2160p@30.

 - **12G-SDI:** Standardized in SMPTE ST-2082 released in 2015, 12Gbit/s bitrate and able to support 2160p@60.

 - **U-SDI:** Technology for transmitting large-volume 8K signals over a single cable. a signal interface called the ultra high definition signal/data interface (U-SDI) for transmitting 4K and 8K signals using a single optical cable. The interface was standardized as the SMPTE ST 2036-4.

 - **HDMI:** High Definition Multimedia Interface: An interface used for the transmission of uncompressed high definition video, up to 8 channels of audio, and control signals, over a single cable.

 - **HDMI 1.3:** released on June 22 2006, and increased the maximum TMDS clock to 340 MHz (10.2 Gbit/s). Support resolution 1920 × 1080 at 120 Hz or 2560 × 1440 at 60 Hz). It added support for 10 bpc, 12 bpc, and 16 bpc color depth (30, 36, and 48 bit/px), called deep color.

● **HDMI 1.4** : released on June 5, 2009, added support for 4096 × 2160 at 24 Hz, 3840 × 2160 at 24, 25, and 30 Hz, and 1920 × 1080 at 120 Hz. Compared to HDMI 1.3, 3 more features added which are HDMI Ethernet Channel (HEC) , audio return channel (ARC),3D Over HDMI, a new Micro HDMI Connector, an expanded set of color spaces.

● **HDMI 2.0**: Released on September 4, 2013 increases the maximum bandwidth to 18.0 Gbit/s. Other features of HDMI 2.0 include up to 32 audio channels, up to 1536 kHz audio sample frequency, the HE-AAC and DRA audio standards, improved 3D capability, and additional CEC functions.

● **HDMI 2.0a**: Was released on April 8, 2015, and added support for High Dynamic Range (HDR) video with static metadata.

● **HDMI 2.0b**: Was released March, 2016, support for HDR Video transport and extends the static metadata signaling to include Hybrid Log-Gamma (HLG).

● **HDMI 2.1**: Released on November 28, 2017. It adds support for higher resolutions and higher refresh rates, Dynamic HDR including 4K 120 Hz and 8K 120 Hz.

● **DisplayPort**: A VESA standard interface primarily for video, but also for audio, USB and other data. DisplayPort (orDP) is backwards compatible with HDMI, DVI and VGA.

● **DP 1.1**: Was ratified on 2 April 2007, and version 1.1a was ratified on 11 January 2008. DisplayPort 1.1 allow a maximum bandwidth of 10.8 Gbit/s (8.64 Gbit/s data rate) over a standard 4-lane main link, enough to support 1920x1080@60Hz.

● **DP 1.2**: Introduced on 7 January 2010, effective bandwidth to 17.28 Gbit/s support increased resolutions, higher refresh rates, and greater color depth, maximum resolution 3840 × 2160@60Hz.

● **DP 1.4**: Publish on 1 Mar, 2016. overall transmission bandwidth 32.4 Gbit/s ,DisplayPort 1.4 adds support for Display Stream Compression 1.2 (DSC), DSC is a "visually lossless" encoding technique with up to a 3:1 compression ratio. Using DSC with HBR3 transmission rates, DisplayPort 1.4 can support 8K UHD (7680 × 4320) at 60 Hz or 4K UHD (3840 × 2160) at 120 Hz with 30 bit/px RGB color and HDR. 4K at 60 Hz 30 bit/px RGB/HDR can be achieved without the need for DSC.

● **Multi-mode Fiber**: Fibers that support many propagation paths or transverse modes are called multi-mode fibers, generally have a wider core diameter and are used for short-distance communication links and for applications where high power must be transmitted.

● **Single-mode Fiber**: Fiber that support a single mode are called single-mode fibers. Single-mode fibers are used for most communication links longer than 1,000 meters (3,300 ft).

●**SFP**: Small form-factor pluggable, is a compact, hot-pluggable network interface module used for both telecommunication and data communications applications.

●**Optical Fiber Connector**: Terminates the end of an optical fiber, and enables quicker connection and disconnection than splicing. The connectors mechanically couple and align the cores of fibers so light can pass. 4 most common types of optical fiber connectors are SC, FC, LC,ST.

●**SC**: (Subscriber Connector), also known as the square connector was also created by the Japanese company – Nippon Telegraph and Telephone. SC is a push-pull coupling type of connector and has a 2.5mm diameter. Nowadays, it is used mostly in single mode fiber optic patch cords, analog, GBIC, and CATV. SC is one of the most popular options, as its simplicity in design comes along with great durability and affordable prices.

●**LC**: (Lucent Connector) is a small factor connector (uses only a 1.25mm ferrule diameter) that has a snap coupling mechanism. Because of its small dimensions, it is the perfect fit for high-density connections, XFP, SFP, and SFP+ transceivers.

●**FC**: (Ferrule Connector) is a screw type connector with a 2.5mm ferrule. FC is a round shaped threaded fiber optic connector,mostly used on Datacom, telecom, measurement equipment, single-mode laser.

●**ST**: (Straight Tip) was invented by AT&T and uses a bayonet mount along with a long spring-loaded ferrule to support the fiber.







●**USB**: Universal Serial Bus is a standard that was developed in the mid-1990s that defines cables, connectors and communication protocols. This technology is designed to allow a connection, communication and power supply for peripheral devices and computers.



●**USB 1.1**: Full-Bandwidth USB, specification was the first release to be widely adopted by the consumer market. This specification allowed for a maximum bandwidth of 12Mbps.

●**USB 2.0**: Or Hi-Speed USB, specification made many improvements over USB 1.1. The main improvement was an increase in bandwidth to a maximum of 480Mbps.

●**USB 3.2**: Super Speed USB with 3 varieties of 3.2 Gen 1(original name USB 3.0), 3.2Gen 2(original name USB 3.1), 3.2 Gen 2x2 (original name USB 3.2) with speed up to 5Gbps,10Gbps,20Gbps respectively.

USB version and connectors figure:

	Type A	Type B	Mini A	Mini B	Micro-A	Micro-B	Type C
USB 2.0							

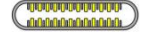
USB 3.0							
USB 3.1&3.2							

●**NTSC:** The colour video standard used in North America and some other parts of the world created by the National Television Standards Committee in the 1950s. NTSC utilizes an interlaced video signals.

●**PAL:** Phase Alternate Line. A television standard in which the phase of the colour carrier is alternated from line to line. It takes four full images (8 fields) for the colour-to-horizontal images (8 fields) for the colour-to-horizontal phase relationship to return to the reference point. This alternation helps cancel out phase errors. For this reason, the hue control is not needed on a PAL TV set. PAL, is widely used in Western Europe, Australia, Africa, the Middle East, and Micronesia. PAL uses 625-line, 50-field (25 fps) composite colour transmission system.

●**SMPTE:** Society of Motion image and Television Engineers. A global organization, based in the United States, that sets standards for baseband visual communications. This includes film as well as video and television standards.

●**VESA:** Video Electronics Standards Association. An organization facilitating computer graphics through standards.

●**HDCP:** High-bandwidth Digital Content Protection (HDCP) was developed by Intel Corporation and is in wide use for protection of video during transmission between devices.

●**HDBaseT:** A video standard for the transmission of uncompressed video (HDMI signals) and related features using Cat 5e/Cat6 cabling infrastructure.

●**ST2110:** A SMPTE developed standard, ST2110 describes how to send digital video over and IP networks. Video is transmitted uncompressed with audio and other data in a separate streams. SMPTE2110 is intended principally for broadcast production and distribution facilities where quality and flexibility are more important.

●**SDVoE:** Software Defined Video over Ethernet (SDVoE) is a method for transmission, distribution and management AV signals using a TCP/IP Ethernet infrastructure for transport with low latency. SDVoE is commonly used in integration applications.

●**Dante AV:** The Dante protocol was developed for and widely adopted in audio systems for the transmission of uncompressed digital audio on IP based networks. The more recent Dante AV

specification includes support for digital video.

● **NDI:** Network Device interface (NDI) is a software standard developed by NewTek to enable video-compatible products to communicate, deliver, and receive broadcast quality video in a high quality, low latency manner that is frame-accurate and suitable for switching in a live production environment over TCP (UDP) Ethernet based networks. NDI is commonly found in broadcast applications.

● **RTMP:** Real-Time Messaging Protocol (RTMP) was initially a proprietary protocol developed by Macromedia (now Adobe) for streaming audio, video and data over the Internet, between a Flash player and a server.

● **RTSP:** The Real Time Streaming Protocol (RTSP) is a network control protocol designed for use in entertainment and communications systems to control streaming media servers. The protocol is used for establishing and controlling media sessions between end points.

● **MPEG:** Moving Picture Experts Group is a working group formed from ISO and IEC developing standards that allow audio/video digital compression and Transmission.

● **H.264:** Also known as AVC (Advanced Video Coding) or MPEG-4i is a common video compression standard. H.264 was standardized by the ITU-T Video Coding Experts Group (VCEG) together with the ISO/IEC JTC1 Moving Picture Experts Group (MPEG).

● **H.265:** Also known as **HEVC** (High Efficiency Video Coding) H.265 is the successor to the widely used H.264/AVC digital video coding standard. Developed under the auspices of ITU, resolutions up to 8192x4320 may be compressed.

● **API:** An Application Programming Interface (API) provides a predefined function which allows access capabilities and features or routines via a software or hardware, without accessing source code or understanding the details of inner working mechanism. An API call may execute a function and/or provide data feedback/report.

● **DMX512:** The communication standard developed by USITT for entertainment and digital lighting systems. The wide adoption of the Digital Multiplex (DMX) protocol has seen the protocol used for a wide range of other devices including video controllers. DMX512 is delivered over cable of 2 twisted pairs with 5pin XLR cables for connection.

● **ArtNet:** An ethernet protocol based on TCP/IP protocol stack, mainly used in entertainment/events applications. Built on the DMX512 data format, ArtNet enables multiple “universes” of DMX512 to be transmitted using ethernet networks for transport.

● **MIDI:** MIDI is the abbreviation of Musical Instrument Digital Interface. As the name indicates the protocol was developed for communication between electronic musical instruments and latterly computers. MIDI instructions are triggers or commands sent over twisted pair cables, typically using 5pin DIN connectors.

● **OSC:** The principle of Open Sound Control (OSC) protocol is for networking sound synthesizers, computers, and multimedia devices for musical performance or show control. As with XML and JSON, the OSC protocol allows sharing data. OSC is transported via UDP packets between devices connected on an Ethernet.

● **Brightness:** Usually refers to the amount or intensity of video light produced on a screen without regard to colour. Sometimes called black level.

● **Contrast Ratio:** The ratio of the high light output level divided by the low light output level. In theory, the contrast ratio of the television system should be at least 100:1, if not 300:1. In reality, there are several limitations. Well-controlled viewing conditions should yield a practical contrast ratio of 30:1 to 50:1.

● **Colour Temperature:** The colour quality, expressed in degrees Kelvin (K), of a light source. The higher the colour temperature, the bluer the light. The lower the temperature, the redder the light. Benchmark colour temperature for the A/V industry include 5000°K, 6500°K, and 9000°K.

● **Saturation:** Chroma, Chroma gain. The intensity of the colour, or the extent to which a given colour in any image is free from white. The less white in a colour, the truer the colour or the greater its saturation. Saturation is the amount of pigment in a colour, and not the intensity.

● **Gamma:** The light output of a CRT is not linear with respect to the voltage input. The difference between what you should have and what is actually output is known as gamma.

● **Frame:** In interlaced video, a frame is one complete image. A video frame is made up of two fields, or two sets of interlaced lines. In a film, a frame is one still image of a series that makes up a motion image.

● **Genlock:** Allows synchronisation of otherwise video devices. A signal generator provides a signal pulses which connected devices can reference. Also see Black Burst and Color Burst.

● **Blackburst:** The video waveform without the video elements. It includes the vertical sync, horizontal sync, and the Chroma burst information. Blackburst is used to synchronize video equipment to align the video output.

● **Colour Burst:** In colour TV systems, a burst of subcarrier frequency located on the back part of the composite video signal. This serves as a colour synchronizing signal to establish a frequency and phase reference for the Chroma signal. Colour burst is 3.58 MHz for NTSC and 4.43 MHz for PAL.

● **Colour Bars:** A standard test pattern of several basic colours (white, yellow, cyan, green, magenta, red, blue, and black) as a reference for system alignment and testing. In NTSC video, the most commonly used colour bars are the SMPTE standard colour bars. In PAL video, the most commonly used colour bars are eight full field bars. On computer monitors the most commonly used colour

bars are two rows of reversed colour bars

● **Seamless Switching:** A feature found on many video switchers. This feature causes the switcher to wait until the vertical interval to switch. This avoids a glitch (temporary scrambling) which often is seen when switching between sources.

● **Scaling:** A conversion of a video or computer graphic signal from a starting resolution to a new resolution. Scaling from one resolution to another is typically done to optimize the signal for input to an image processor, transmission path or to improve its quality when presented on a particular display.

● **PIP:** Picture-In-Picture. A small image within a larger image created by scaling down one of image to make it smaller. Other forms of PIP displays include Picture-By-Picture (PBP) and Picture- With-Picture (PWP), which are commonly used with 16:9 aspect display devices. PBP and PWP image formats require a separate scaler for each video window .

● **HDR:** is a high dynamic range (HDR) technique used in imaging and photography to reproduce a greater dynamic range of luminosity than what is possible with standard digital imaging or photographic techniques. The aim is to present a similar range of luminance to that experienced through the human visual system.

● **UHD:** Standing for Ultra High Definition and comprising 4K and 8K television standards with a 16:9 ratio, UHD follows the 2K HDTV standard. A UHD 4K display has a physical resolution of 3840x2160 which is four times the area and twice both the width and height of a HDTV/FullHD (1920x1080) video signal.

● **EDID:** Extended Display Identification Data. EDID is a data structure used to communicate video display information, including native resolution and vertical interval refresh rate requirements, to a source device. The source device will then output the provided EDID data, ensuring proper video image quality.

5.4 Revision History

The table below lists the changes to the User Manual.

Version	Date	ECO#	Description	Editor
V1.0	2023-11-28	0000#	First release.	Aster

All information herein is Xiamen RGBlink Science & Technology Co Ltd. excepting noted.

RGBlink is a registered trademark of Xiamen RGBlink Science & Technology Co Ltd.

While all efforts are made for accuracy at time of printing, we reserve the right to alter otherwise make change without notice.